

Revalco[®]

Made in Italy

measurement transducers

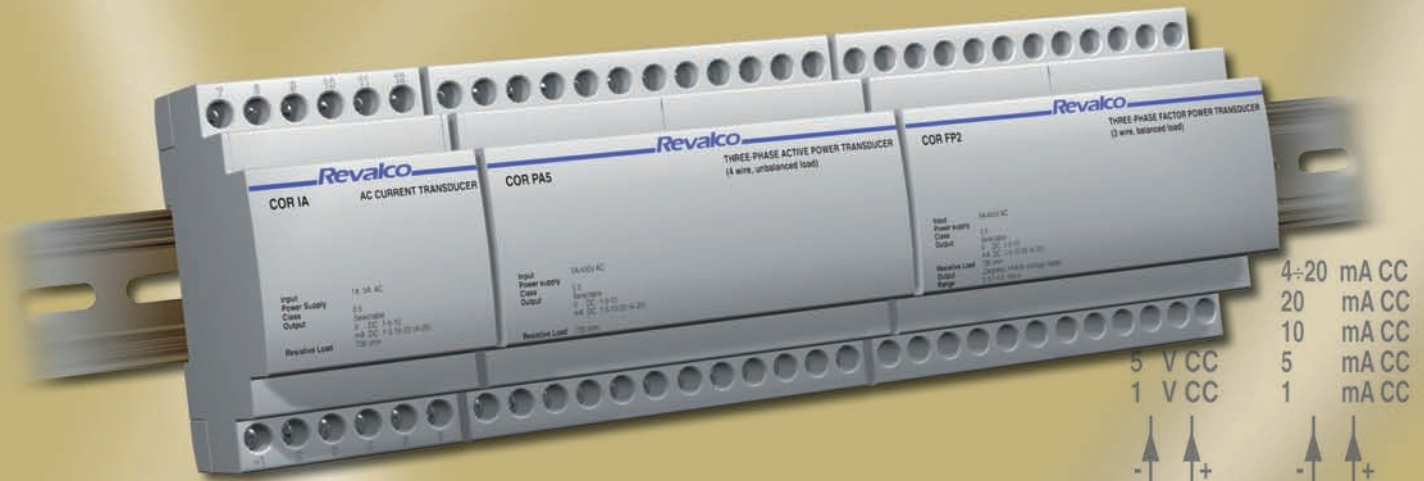

4-20 mA CC
20 mA CC
10 mA CC
5 mA CC
1 mA CC



Alimentazione
1A max
5A max



USCITE SELEZIONABILI

1	2	3	4	5	6	1	2	3	4	5	6	Output
<input type="checkbox"/>	<input type="checkbox"/>	<input type="checkbox"/>	<input type="checkbox"/>	<input type="checkbox"/>	<input type="checkbox"/>	<input type="checkbox"/>	<input type="checkbox"/>	<input type="checkbox"/>	<input type="checkbox"/>	<input type="checkbox"/>	<input type="checkbox"/>	OFF
<input type="checkbox"/>	<input type="checkbox"/>	<input type="checkbox"/>	<input type="checkbox"/>	<input type="checkbox"/>	<input type="checkbox"/>	<input type="checkbox"/>	<input type="checkbox"/>	<input type="checkbox"/>	<input type="checkbox"/>	<input type="checkbox"/>	<input type="checkbox"/>	ON
<input type="checkbox"/>	<input type="checkbox"/>	<input type="checkbox"/>	<input type="checkbox"/>	<input type="checkbox"/>	<input type="checkbox"/>	<input type="checkbox"/>	<input type="checkbox"/>	<input type="checkbox"/>	<input type="checkbox"/>	<input type="checkbox"/>	<input type="checkbox"/>	OFF
<input type="checkbox"/>	<input type="checkbox"/>	<input type="checkbox"/>	<input type="checkbox"/>	<input type="checkbox"/>	<input type="checkbox"/>	<input type="checkbox"/>	<input type="checkbox"/>	<input type="checkbox"/>	<input type="checkbox"/>	<input type="checkbox"/>	<input type="checkbox"/>	ON
<input type="checkbox"/>	<input type="checkbox"/>	<input type="checkbox"/>	<input type="checkbox"/>	<input type="checkbox"/>	<input type="checkbox"/>	<input type="checkbox"/>	<input type="checkbox"/>	<input type="checkbox"/>	<input type="checkbox"/>	<input type="checkbox"/>	<input type="checkbox"/>	OFF
<input type="checkbox"/>	<input type="checkbox"/>	<input type="checkbox"/>	<input type="checkbox"/>	<input type="checkbox"/>	<input type="checkbox"/>	<input type="checkbox"/>	<input type="checkbox"/>	<input type="checkbox"/>	<input type="checkbox"/>	<input type="checkbox"/>	<input type="checkbox"/>	ON
<input type="checkbox"/>	<input type="checkbox"/>	<input type="checkbox"/>	<input type="checkbox"/>	<input type="checkbox"/>	<input type="checkbox"/>	<input type="checkbox"/>	<input type="checkbox"/>	<input type="checkbox"/>	<input type="checkbox"/>	<input type="checkbox"/>	<input type="checkbox"/>	OFF
<input type="checkbox"/>	<input type="checkbox"/>	<input type="checkbox"/>	<input type="checkbox"/>	<input type="checkbox"/>	<input type="checkbox"/>	<input type="checkbox"/>	<input type="checkbox"/>	<input type="checkbox"/>	<input type="checkbox"/>	<input type="checkbox"/>	<input type="checkbox"/>	ON

2011

Revalco

MEASUREMENT TRANSDUCERS

GENERAL DESCRIPTION, ORDERING DATA, WAVEFORM, DIMENSIONS in mm	171
LINEARITY DIAGRAMS BETWEEN INPUTS AND OUTPUTS	171
MEASUREMENT TRANSDUCERS - TRUE RMS	172
AC/DC CURRENT TRANSDUCERS	173
AC/DC VOLTAGE TRANSDUCERS	174
DC CURRENT/VOLTAGE TRANSDUCERS, 1 MODULE	175
SINGLE PHASE/THREE PHASE POWER FACTOR TRANSDUCERS	178
FREQUENCY TRANSDUCERS	178
SINGLE PHASE ACTIVE AND REACTIVE POWER TRANSDUCERS	179
THREE PHASE ACTIVE AND REACTIVE POWER TRANSDUCERS	
Three phase, balanced load, 3 wires without neutral / Three phase, unbalanced load, 3 wires without neutral (ARON) .	180
Three phase, balanced load, 4 wires with neutral / Three phase, unbalanced load, 4 wires with neutral	181

GENERAL DESCRIPTION

- The transducer is a device that measures a given electrical parameter, which is then through electronic circuitry, converted to a DC signal, which is directly proportional to the input, to allow remote indication without loss of accuracy.
- The **Revalco** range of transducers, having galvanic separation between Input and Output, has been developed to a high specification giving the user, confidence with the Accuracy and Linearity over a wide range of measured parameters. Having Low Power Consumption while being unaffected by any changes in Temperature, Vibration or Load, ensures this range is suitable for many applications in the Power Monitoring and Distribution fields.
- **Revalco** transducers have been designed with the ever changing needs of the market in mind. Each item has incorporated the ability to select any of the recognised outputs of both DC mA and DC V by simple selection of minidip keys located under a removable section of the upper case wall
- Standards: EN61010-1; EN60688; EN61000-6-4; EN61000-6-2

ORDERING DATA

- The three phase active and reactive power transducers are calibrated with the following standard values:
Current input 5A and the primary values are selectable by minidips
Voltage input 400V
- On request it is possible to calibrate the transducers with the following parameters which must be indicated when ordering:
Current input 1A
Voltage input: 100/ $\sqrt{3}$ V, 110/ $\sqrt{3}$ V, 100V, 110V, 230V, 440V, 500V
- When ordering, the end scale value must be indicated

WAVEFORM

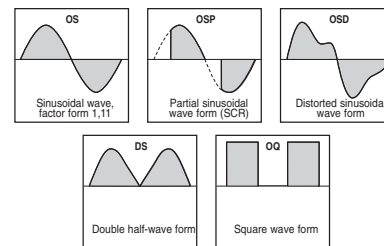

LINEARITY DIAGRAMS BETWEEN INPUTS AND OUTPUTS

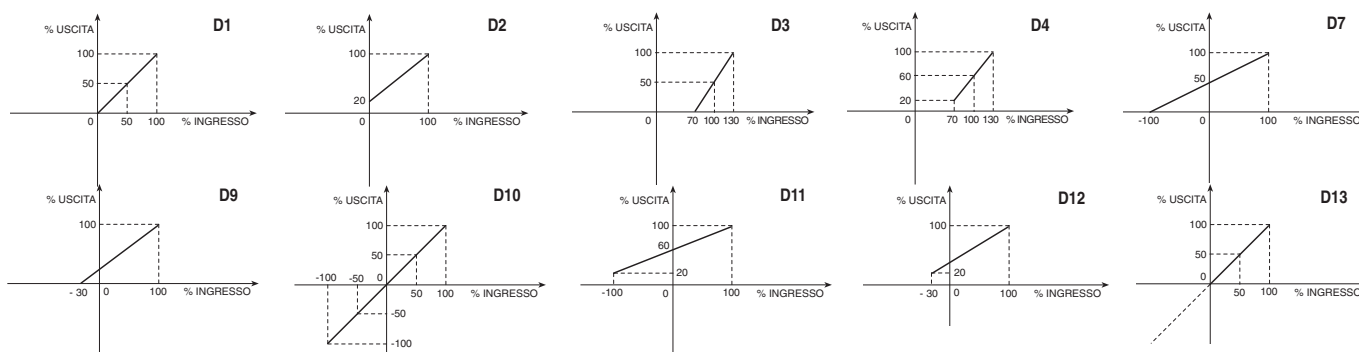

DIMENSIONS in mm

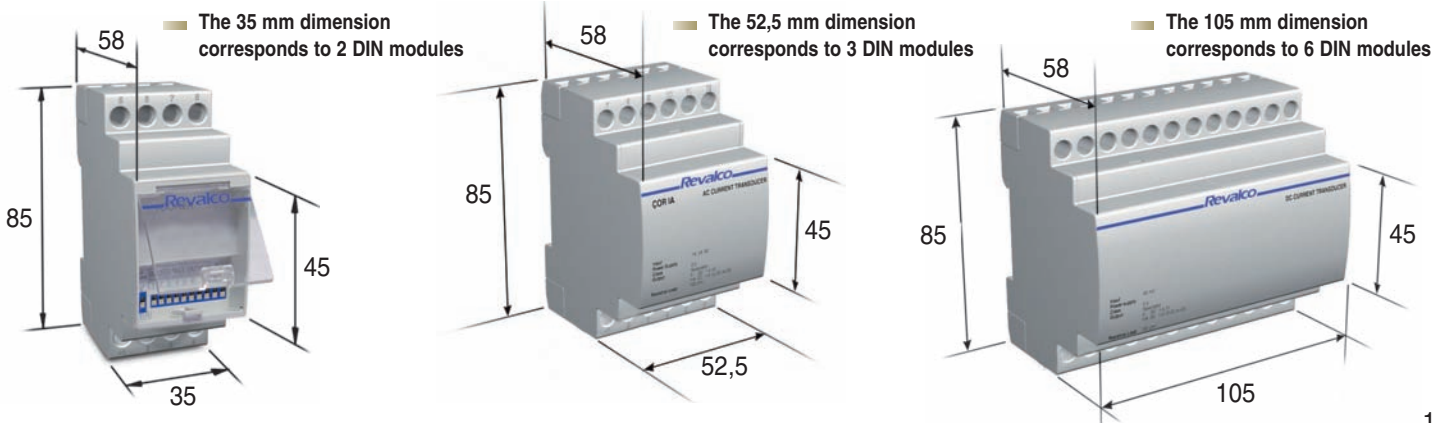

MEASUREMENT TRANSDUCERS - TRUE RMS

SINGLE PHASE

- Auxiliary power supply: see table
- Input nominal values: see table
- Response time ≤ 300 ms
- Dimensions: 2 DIN modules
- Resistive load: 700Ω
- Selectable output nominal values 1-5-10VDC and 1-5-10-20-4/20mA DC
- $\pm 1, \pm 5, \pm 10$ VDC and $\pm 1, \pm 5, \pm 10, \pm 20, 4/20$ mA DC
- Class 0,5
- Transparent sealable front cover



	230	1COR2A...	1COR2V...	1COR2F...	1COR2P...	1COR2C...
Current transducers	230	•				
Voltage transducers	230		•			
Frequency transducers	230			•		
Single phase active power transducers	230				•	
DC line power transducers	230					•
Sole power supply 24VAC	24	•	•	•	•	•
Sole power supply 110VAC	110	•	•	•	•	•
Sole power supply 22...36VAC and 19...70VDC	-P1	•	•	•	•	•
Sole power supply 44...130VAC and 70...240VDC	-P2	•	•	•	•	•

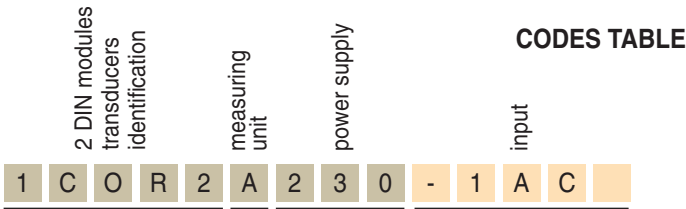

- 230 = 230VAC
- 24 = 24VAC
- 110 = 110VAC
- P1 = 22...36VAC and 19...70VDC
- P2 = 44...130VAC and 70...240VDC

- A = current
- V = voltage
- F = frequency
- P = active power
- C = DC line power

- 1AC = input 1A AC (internal CT measurement)
- 5AC = input 5A AC (internal CT measurement)
- 5DC = input 5A DC
- 10DC = input 10A DC
- 60MV = input 60mV DC (or -100MV / -150MV / -300MV)
- 500V = input 500V AC or DC
- 100V = input 100V AC or DC
- 110V = input 110V AC or DC
- 150V = input 150V AC or DC
- 250V = input 250V AC or DC
- 100R3V = input $100V:\sqrt{3}$ AC or DC
- 110R3V = input $110V:\sqrt{3}$ AC or DC
- 4555HZ = input 45/55 Hz
- 4565HZ = input 45/65 Hz
- 5A500V = calibration 5A 500V AC (internal CT measurement)
- 5A50V = calibration 5A 50V DC (voltage/current measure has a common point)

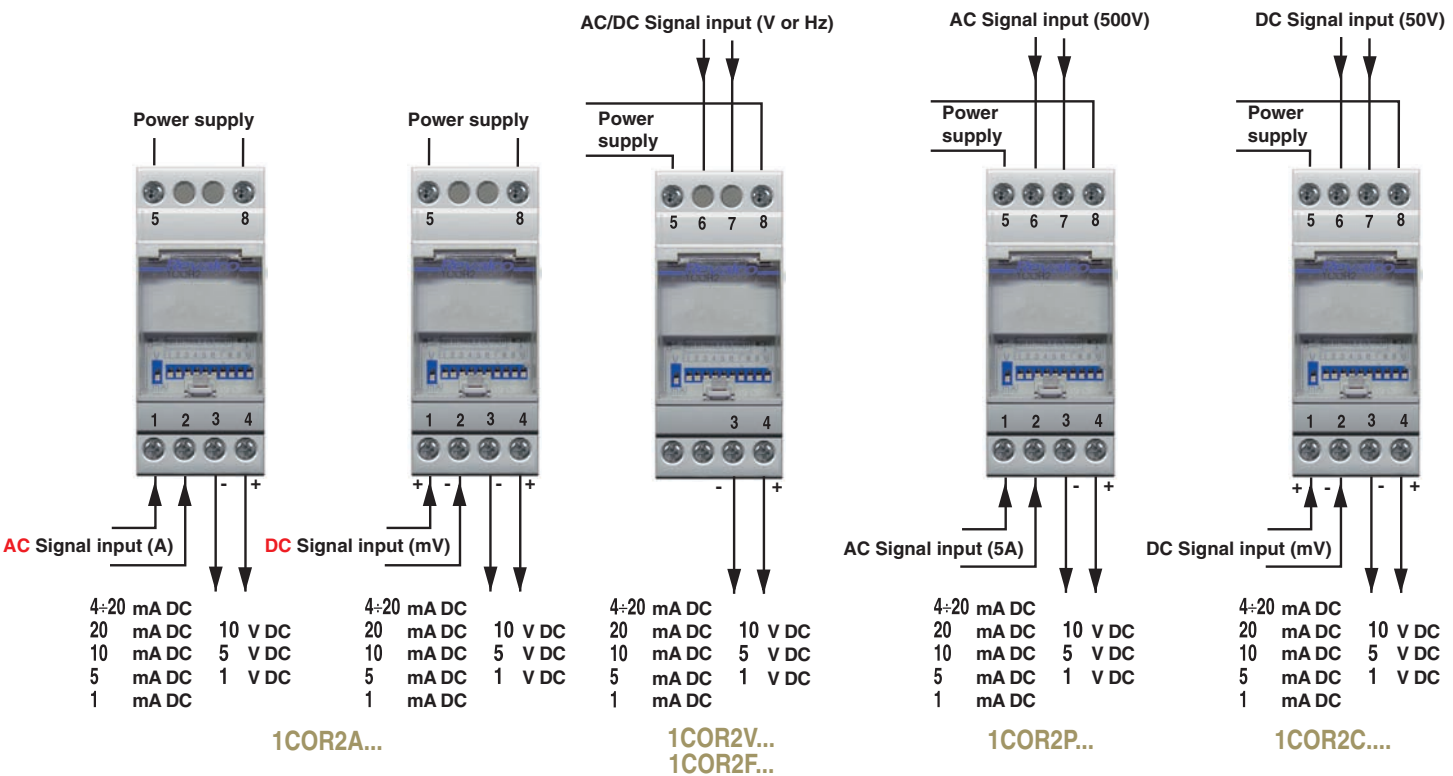
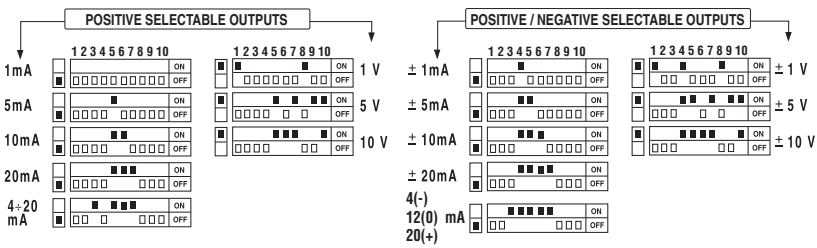

MEASUREMENT TRANSDUCERS

CURRENT TRANSDUCERS

SELF SUPPLIED

- NOMINAL INPUT VALUES
- NOMINAL OUTPUT VALUES
- RESISTIVE LOAD
- MEASURING RANGE
- ACCURACY CLASS
- OVERLOAD
- RESPONSE TIME
- ALTERNATED RESIDUAL
- OPERATING FREQUENCY
- BURDEN
- GALVANIC SEPARATION BETWEEN INPUTS AND OUTPUTS
- OPERATING TEMPERATURE
- INPUT WAVE FORM
- DIMENSIONS / WEIGHT kg.
- Different technical characteristic can be considered, under specific requests

	1CORIAA5 20	1CORIAA1 20	1CORIAA5 10	1CORIAA1 10
NOMINAL INPUT VALUES	5A	1A	5A	1A
NOMINAL OUTPUT VALUES	20 mA CC	20 mA CC	10 V CC	10 V CC
RESISTIVE LOAD	300Ω	300Ω	>10kΩ	>10kΩ
MEASURING RANGE			0 ÷ In	
ACCURACY CLASS			1	
OVERLOAD		Permanent: 1,2 In	Instantaneous: 10 In for 1 sec.	
RESPONSE TIME			≤ 300 ms	
ALTERNATED RESIDUAL			≤ 2%	
OPERATING FREQUENCY			50/60 Hz	
BURDEN			3 VA	
GALVANIC SEPARATION BETWEEN INPUTS AND OUTPUTS		2kV for 1min at 50Hz		
OPERATING TEMPERATURE		0 °C ÷ +55 °C		
INPUT WAVE FORM		OS		
DIMENSIONS / WEIGHT kg.		2 DIN modules / 0,25		



EXTERNAL POWER SUPPLY

- AUXILIARY SUPPLY (separate)
- NOMINAL INPUT VALUES
- NOMINAL OUTPUT VALUES (selectable)
- RESISTIVE LOAD
- MEASURING RANGE
- ACCURACY CLASS
- OVERLOAD
- RESPONSE TIME
- ALTERNATED RESIDUAL
- OPERATING FREQUENCY
- BURDEN
- GALVANIC SEPARATION BETWEEN INPUTS AND OUTPUTS
 - insulation between inputs, outputs, power supply
 - insulation between the all circuits and earth
- OPERATING TEMPERATURE
- INPUT WAVE FORM
- DIMENSIONS / WEIGHT Kg.
- Different technical characteristic can be considered, under specific requests

AUXILIARY SUPPLY (separate)	230V AC standard
NOMINAL INPUT VALUES	1A and 5A present on the same transducer
NOMINAL OUTPUT VALUES (selectable)	1 - 5 - 10 VDC and 1 - 5 - 10 - 20 - 4/20 mA DC
RESISTIVE LOAD	700Ω
MEASURING RANGE	0 ÷ In
ACCURACY CLASS	0,5
OVERLOAD	Permanent: 2 In
RESPONSE TIME	Instantaneous: 10 In for 1 sec.
ALTERNATED RESIDUAL	≤ 300 ms
OPERATING FREQUENCY	≤ 1%
BURDEN	50/60 Hz
GALVANIC SEPARATION BETWEEN INPUTS AND OUTPUTS	current circuit: ≤ 0,8 VA - power supply: ≤ 4VA
OPERATING TEMPERATURE	2kV for 1min at 50Hz
INPUT WAVE FORM	4kV for 1min at 50Hz
DIMENSIONS / WEIGHT Kg.	0 °C ÷ +55 °C
	OS
	6 DIN modules (3 DIN modules) / 0,54 (0,27)

DC CURRENT - 1CORIC

The selection of the required output is achieved by adjusting the minidip keys as described in the following diagram:

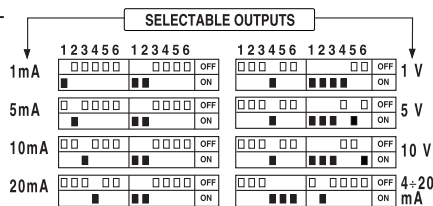

Where a Voltage output is required connection is by terminal N 13 and 14; for Current output connect to terminals N 17 and 18.

AC CURRENT - 1CORIA

The selection of the required output is achieved by adjusting the minidip keys as described in the following diagram:

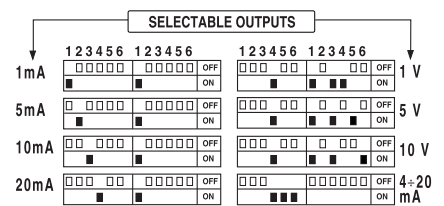

Where a Voltage output is required connection is by terminal N 7 and 8; for Current output connect to terminal N 11 and 12.

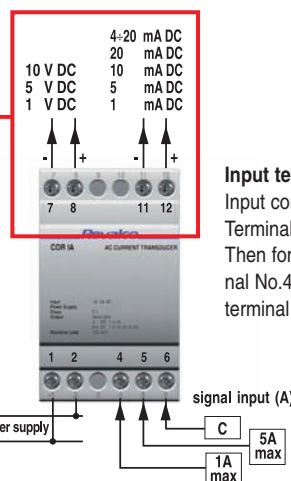
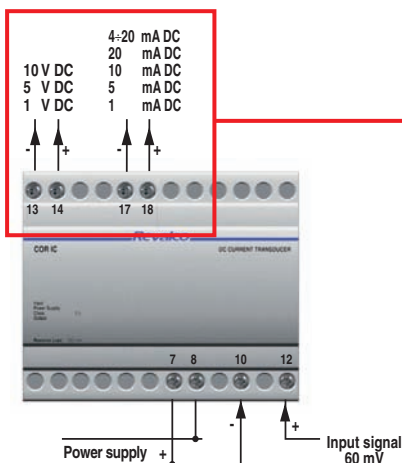

Input terminal selection

Input connection is achieved by using Terminal C (No.6) for the common. Then for an Input of 1 Amp select terminal No.4 and for an Input of 5 Amp select terminal No.5 (as shown in the diagram)

VOLTAGE TRANSDUCERS

SELF SUPPLIED

	1CORUAA 100 20	1CORUAA 100R3 20	1CORUAA 230 20	1CORUAA 400 20	1CORUAA 100 10	1CORUAA 100R3 10	1CORUAA 230 10	1CORUAA 400 10
- NOMINAL INPUT VALUES	100V	100:√3V	230V	400V	100V	100:√3V	230V	400V
- NOMINAL OUTPUT VALUES	20 mA DC	20 mA DC	20 mA DC	20 mA DC	10 V DC	10 V DC	10 V DC	10 V DC
- RESISTIVE LOAD	300Ω	300Ω	300Ω	300Ω	>10kΩ	>10kΩ	>10kΩ	>10kΩ
- MEASURING RANGE	0 ÷ In							
- ACCURACY CLASS	1							
- OVERLOAD	Permanent: 1,2 In Instantaneous: 10 In for 1 sec.							
- RESPONSE TIME	≤ 300 ms							
- ALTERNATED RESIDUAL	≤ 2%							
- OPERATING FREQUENCY	50/60 Hz							
- BURDEN	3 VA							
- GALVANIC SEPARATION BETWEEN INPUTS AND OUTPUTS	2kV for 1min at 50Hz							
- OPERATING TEMPERATURE	0 °C ÷ +55 °C							
- INPUT WAVE FORM	OS							
- DIMENSIONS / WEIGHT Kg.	2 DIN modules / 0,25							
- Different technical characteristic can be considered, under specific requests								



EXTERNAL POWER SUPPLY

- AUXILIARY SUPPLY (separate)	230V AC standard
- NOMINAL INPUT VALUES	to be specified when ordering
- NOMINAL OUTPUT VALUES (selectable)	1 - 5 - 10 VDC and 1 - 5 - 10 - 20 - 4/20 mA DC
- RESISTIVE LOAD	700Ω
- MEASURING RANGE	0 ÷ In
- ACCURACY CLASS	0,5
- OVERLOAD	Permanent: 2 In Instantaneous: 10 In for 1 sec.
- RESPONSE TIME	≤ 300 ms
- ALTERNATED RESIDUAL	≤ 1%
- OPERATING FREQUENCY	50/60 Hz
- BURDEN	current circuit: ≤ 0,8 VA - power supply: ≤ 4VA
- GALVANIC SEPARATION BETWEEN INPUTS AND OUTPUTS	2kV for 1min at 50Hz 4kV for 1min at 50Hz
• insulation between inputs, outputs, power supply	0 °C ÷ +55 °C
• insulation between the all circuits and earth	OS
- OPERATING TEMPERATURE	6 DIN modules (3 DIN modules) / 0,54 (0,27)
- INPUT WAVE FORM	
- DIMENSIONS / WEIGHT Kg.	
- Different technical characteristic can be considered, under specific requests	

DC VOLTAGE - 1CORUC

The selection of the required output is achieved by adjusting the minidip keys as described in the following diagram:

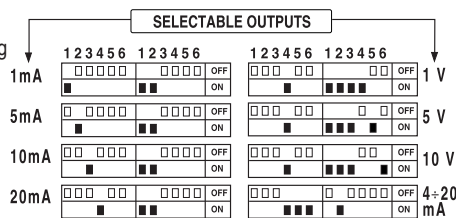

Where a Voltage output is required connection is by terminal Nos, 13 and 14 and for Current output connect to terminal Nos, 17 and 18.

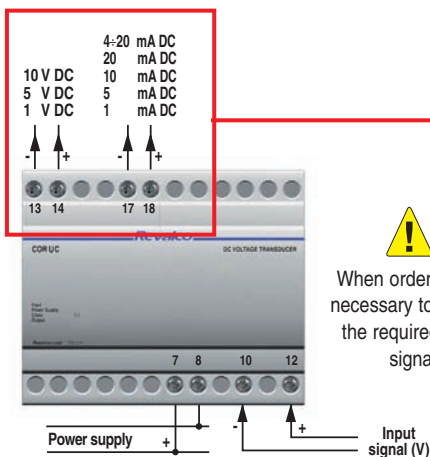

AC VOLTAGE - 1CORUA

The selection of the required output is achieved by adjusting the minidip keys as described in the following diagram:

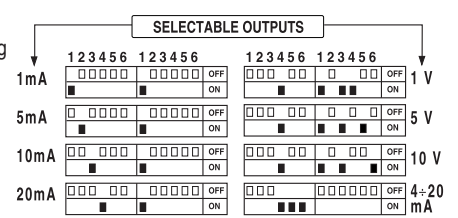

Where a Voltage output is required connection is by terminal Nos, 7 and 8 and for Current output connect to terminal Nos, 11 and 12.

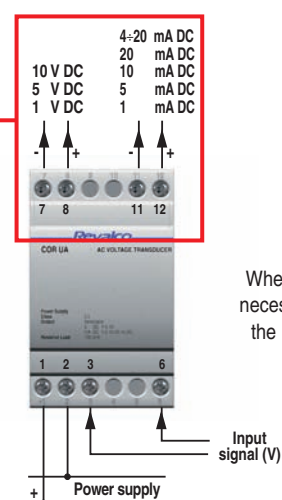

MEASUREMENT TRANSDUCERS - 1 DIN MODULE

CURRENT TRANSDUCERS

OUTPUT 4/20mA

- AUXILIARY SUPPLY
- BURDEN

1CORIC1-10A | 1CORIC1-15A | 1CORIC1-20A | 1CORIC1-25A

24VDC +/- 10%
32mA no load, 36 mA at 4mA
41 mA at 12mA, 47mA at 20mA

- INPUT VALUES
(single or bipolar to specify when ordering)

10A DC | 15A DC | 20A DC | 25A DC

- INTERNAL SHUNT (resistance)

3 mΩ | 3 mΩ | 2 mΩ | 1 mΩ

- DISSIPATION POWER

0,3 W | 0,675 W | 0,8 W | 0,625 W

- MAXIMUM CURRENT FOR 1 sec

60A

- RESISTIVE LOAD

500Ω max

- ACCURACY CLASS

1%

- RESPONSE TIME

1 sec

- GALVANIC SEPARATION

(insulation between inputs, outputs and power supply)

2kV for 1min at 50Hz

- TEMPERATURE

-5 °C ÷ +55 °C

- DIMENSIONS / WEIGHT kg.

1 DIN module / 0,27

- READING FILTER

YES

- STANDARDS

CE, EN 61010-1, EN 60742, EN 61000-6-4, EN 61000-6-2

- FUNCTIONING INDICATORS Red led (actual measure): it flashes during the measurement of input current

Green led (active output): it flashes while the current value is converting

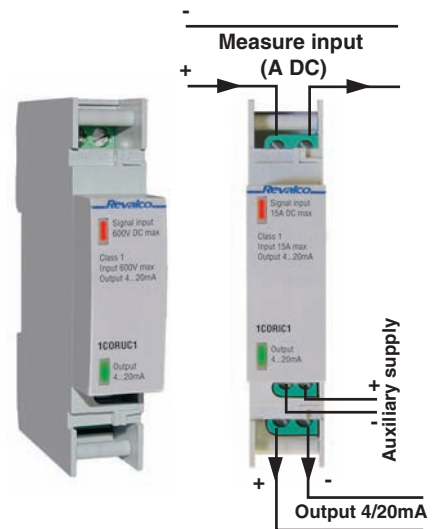

OUTPUT RS485 – Address and speed selectable by frontal minidip

- AUXILIARY SUPPLY
- BURDEN

1CORIC1-10A-RS | 1CORIC1-15A-RS | 1CORIC1-20A-RS | 1CORIC1-25A-RS

24VDC +/- 10%

- INPUT VALUES
(single or bipolar to specify when ordering)

10A DC | 15ADC | 20A DC | 25A DC

- INTERNAL SHUNT (resistance)

3 mΩ | 3 mΩ | 2 mΩ | 1 mΩ

- DISSIPATION POWER

0,3 W | 0,675 W | 0,8 W | 0,625 W

- MAXIMUM CURRENT FOR 1 sec

60A

- RESISTIVE LOAD

500Ω max

- ACCURACY CLASS

1%

- RESPONSE TIME

1 sec

- GALVANIC SEPARATION

(insulation between inputs, outputs and power supply)

2kV for 1min at 50Hz

- TEMPERATURE

-5 °C ÷ +55 °C

- DIMENSIONS / WEIGHT kg.

1 DIN module / 0,27

- READING FILTER

YES

- STANDARDS

CE, EN61010-1, EN60688, EN61000-6-4, EN61000-6-2

- FUNCTIONING INDICATORS Green led (actual measure): it flashes during the measurement of input current

- MAX 32 DEVICES ON THE SAME RING, FOR MORE QUANTITIES USE REPEATERS OR RS485 CONCENTRATOR

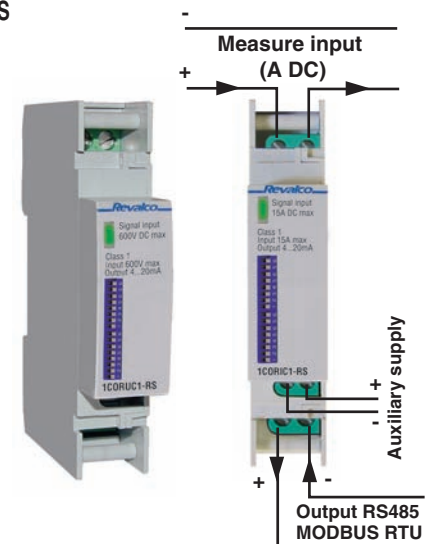

Selection of binary MODBUS node number

Address	Dip 8 (H)	Dip 7	Dip 6	Dip 5	Dip 4	Dip 3	Dip 2	Dip 1(L)
1	OFF	OFF	OFF	OFF	OFF	OFF	OFF	ON
24	OFF	OFF	OFF	ON	ON	OFF	OFF	OFF
253	ON	ON	ON	ON	ON	ON	OFF	ON

Note: node 0 selection cannot be used (module doesn't answer)

Selection of RS485 speed

Speed (bps)	Dip 12	Dip 11	Dip 10	Dip 9
9600	OFF	OFF	OFF	OFF
19200	OFF	OFF	OFF	ON
38400	OFF	OFF	ON	OFF
57600	OFF	OFF	ON	ON
115200	OFF	ON	OFF	OFF

VOLTAGE TRANSDUCERS

OUTPUT 4/20mA

- | | |
|--------------------------|---|
| - AUXILIARY SUPPLY | 24VDC +/- 10% |
| - BURDEN | 32mA no load, 36 mA at 4mA
41 mA at 12mA, 47mA at 20mA |
| - INPUT VALUES | single pole
600 VDC max 1200 VDC max |
| - RESISTIVE LOAD | 500Ω max |
| - ACCURACY CLASS | 1% |
| - RESPONSE TIME | 1 sec |
| - GALVANIC SEPARATION | (insulation between inputs, outputs and power supply) 2kV for 1min at 50Hz |
| - TEMPERATURE | -5 °C ÷ +55 °C |
| - DIMENSIONS / WEIGHT kg | 1 DIN module / 0,27 |
| - READING FILTER | YES |
| - STANDARDS | CE, EN 61010-1, EN 60742, EN 61000-6-4, EN 61000-6-2 |
| - FUNCTIONING INDICATORS | Red led (actual measure): it flashes during the measurement of input current
Green led (active output): it flashes while the current value is converting |

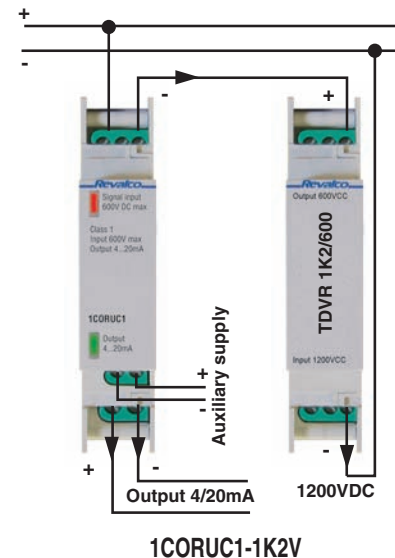
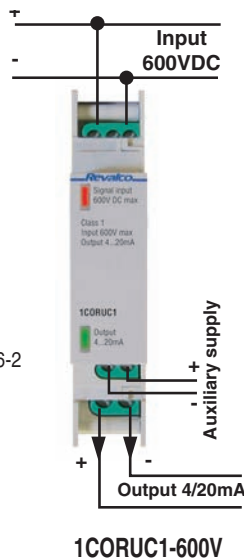

OUTPUT RS485 – Address and speed selectable by frontal minidip

- | | |
|--|--|
| - AUXILIARY SUPPLY | 24VDC +/- 10% |
| - BURDEN | 80 mA |
| - INPUT VALUES | single pole
600 VDC max 1200 VDC max |
| - RESISTIVE LOAD | 500Ω max |
| - ACCURACY CLASS | 1% |
| - RESPONSE TIME | 1 sec |
| - GALVANIC SEPARATION | (insulation between inputs, outputs and power supply) 2kV for 1min at 50Hz |
| - TEMPERATURE | -5 °C ÷ +55 °C |
| - DIMENSIONS / WEIGHT kg. | 1 DIN module / 0,27 |
| - READING FILTER | YES |
| - STANDARDS | CE, EN61010-1, EN60688, EN61000-6-4, EN61000-6-2 |
| - FUNCTIONING INDICATORS | Green led (actual measure): it flashes during the measurement of input current |
| - MAX 32 DEVICES ON THE SAME RING, FOR MORE QUANTITIES USE REPEATERS OR RS485 CONCENTRATOR | |

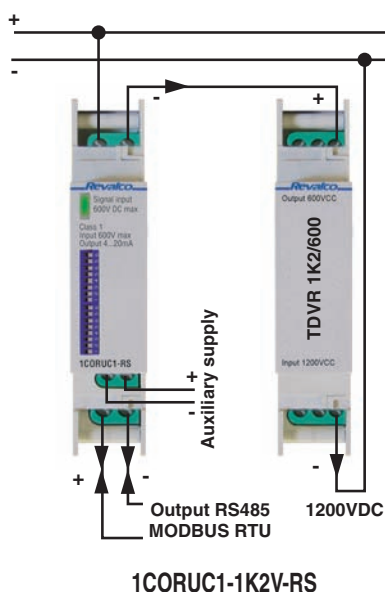
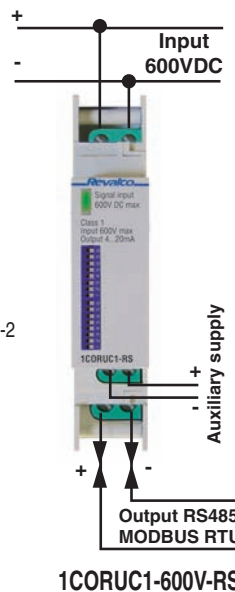

Selection of binary MODBUS node number

Address	Dip 8 (H)	Dip 7	Dip 6	Dip 5	Dip 4	Dip 3	Dip 2	Dip 1 (L)
1	OFF	OFF	OFF	OFF	OFF	OFF	OFF	ON
24	OFF	OFF	OFF	ON	ON	OFF	OFF	OFF
253	ON	ON	ON	ON	ON	ON	OFF	ON

Note: node 0 selection cannot be used (module doesn't answer)

Selection of RS485 speed

Speed (bps)	Dip 12	Dip 11	Dip 10	Dip 9
9600	OFF	OFF	OFF	OFF
19200	OFF	OFF	OFF	ON
38400	OFF	OFF	ON	OFF
57600	OFF	OFF	ON	ON
115200	OFF	ON	OFF	OFF

RS485 CONCENTRATOR - 1RCD1485

Impulses concentrator for 2 ... 32 devices in one sole serial output RS485

- **AUXILIARY SUPPLY** 24VDC +/- 10%
- **INPUT** serial RS485 MODBUS RTU SLAVE with address and transmission speed selectable by a frontal minidip
- **OUTPUT** serial RS485 (9600 Bps) MODBUS RTU master to the transducers (max 32)
- **GALVANIC SEPARATION** (insulation between RS485); 2kV for 1min at 50Hz (high frequency transformer)
- **TEMPERATURE** -5 °C ÷ +55 °C
- **DATA CONTROL** Software CRC
- **STANDARDS** CE, EN 61010-1, EN 60742, EN 61000-6-4, EN 61000-6-2
- **FUNCTIONING INDICATORS** Red = TX master, Yellow = RX master, Green = TX slave, White = RX slave

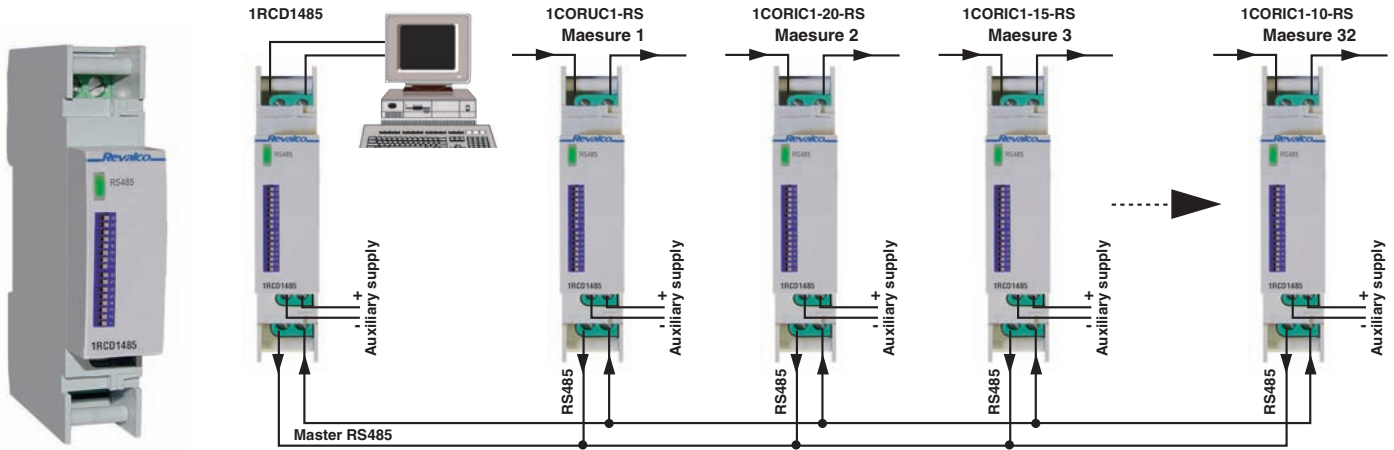

Selection of binary MODBUS node number

Address	Dip 8 (H)	Dip 7	Dip 6	Dip 5	Dip 4	Dip 3	Dip 2	Dip 1(L)
1	OFF	OFF	OFF	OFF	OFF	OFF	OFF	ON
24	OFF	OFF	OFF	ON	ON	OFF	OFF	OFF
253	ON	ON	ON	ON	ON	ON	OFF	ON

Note: node 0 selection cannot be used (module doesn't answer)

Selection of RS485 speed

Speed (bps)	Dip 12	Dip 11	Dip 10	Dip 9
9600	OFF	OFF	OFF	OFF
19200	OFF	OFF	OFF	ON
38400	OFF	OFF	ON	OFF
57600	OFF	OFF	ON	ON
115200	OFF	ON	OFF	OFF

EXAMPLE OF REMOTE MEASUREMENT GROUP USE

- It is possible to combine several current and/or voltage modules up to 32 units maximum with the scope to realize one local measurement unit.
- Not necessarily these modules need to be matched; they can be deployed in an area and then concentrated on the global bus.
- A concentrator module collects inside it, automatically, all measurement data present on the local bus and makes them available, all together, on the global bus having as reference only one modbus address.
- The measures collection system can be a mix of local units concentrated, and individual modules up to the saturation of modbus addresses.**
- The whole system can be designed flexibly, modified at any time, easily expanded or supplemented in subsequent times
- Modules allow the removal or installation also in the presence of auxiliary power

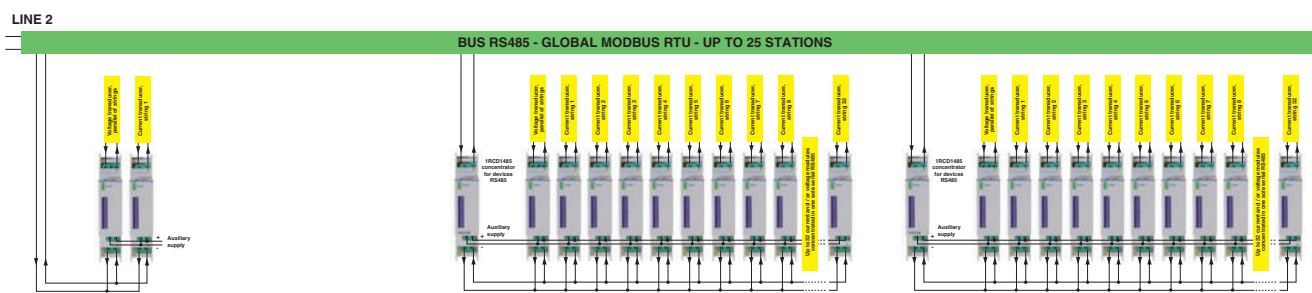
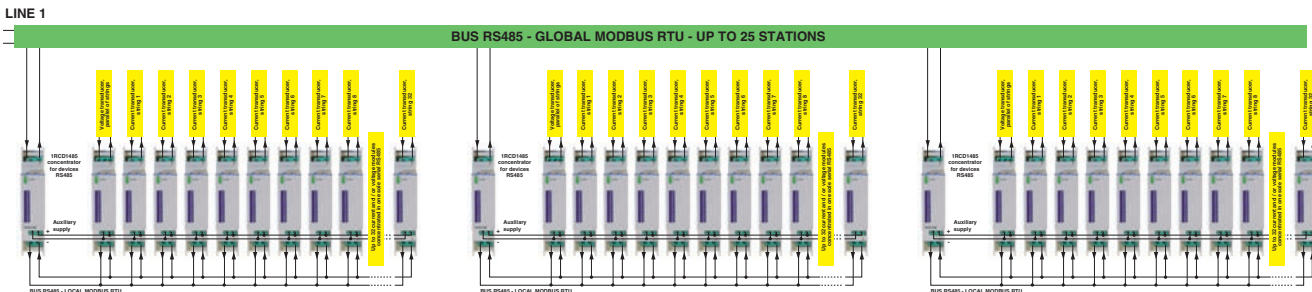
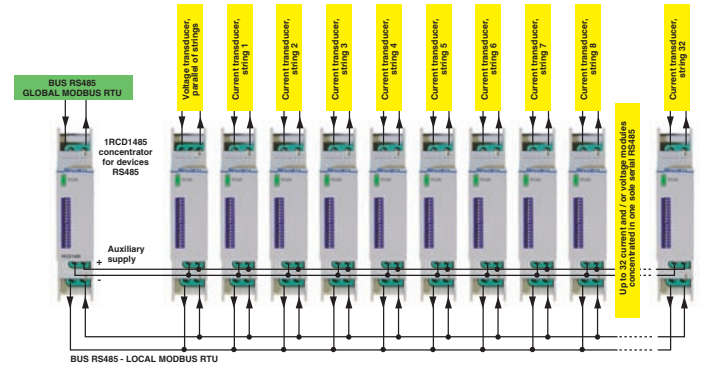

Data acquisition system from remote, up to 250 measures groups (2x125)

POWER FACTOR TRANSDUCERS

1CORFP10 - 1CORFP20

The transducer have galvanic separation between inputs and outputs and the capability to offer multiple choice by terminal selection and 8 outputs (± 1 , ± 5 , ± 10 VDC and ± 1 , ± 5 , ± 10 , ± 20 , 4/20 mA DC). It is also possible to select the required conversion between:

- **proportional to the phase angle**, with output 1mA DC (in degrees) for connection with an analogue measuring instrument.
- **proportional to $\cos \phi$** with output ± 1 , ± 5 , ± 10 , ± 20 , $\pm 4/20$ mA and ± 1 , ± 5 , ± 10 V for all other use

- **AUXILIARY SUPPLY (separate)**
- **NOMINAL INPUT VALUES VOLTAGE**

1CORFP10 - Single phase
 230V AC standard
 230V AC 50/60 Hz
 current: 5A (1A on 1CORFP...B type)
 ± 1 , ± 5 , ± 10 VDC and ± 1 , ± 5 , ± 10 , ± 20 , 4/20 mA DC
 700 Ω max / 0,5

1CORFP20 - Three phase, balanced load, 3 wires
 230V / 400V AC standard
 400V AC 50/60 Hz
 current: 5A (1A on 1CORFP...B type)

- **NOMINAL OUTPUT VALUES (selectable)**
- **RESISTIVE LOAD / ACCURACY CLASS**
- **MEASURING RANGE**
- **OVERLOAD**
- **RESPONSE TIME / ALTERNATED RESIDUAL**
- **BURDEN**
- **GALVANIC SEPARATION BETWEEN INPUTS AND OUTPUTS**

0,5 (cap) - 1 - 0,5 (ind) standard
Permanent: 2 In / 1,2 Un - **Instantaneous:** 10 In / 2 Un for 1 sec
 ≤ 300 ms / $\leq 1\%$

voltage circuit ≤ 1 VA current circuit $\leq 0,8$ VVA power supply ≤ 4 VVA
 insulation between inputs, outputs, power supply 2kV for 1min at 50Hz
 insulation between the all circuits and earth 4kV for 1min at 50Hz
 0 °C \div +55 °C / OS - OSD (schemes D10, D2)
 6 DIN modules / 0,50

- **OPERATING TEMPERATURE / INPUT WAVE FORM**
- **DIMENSIONS / WEIGHT Kg.**
- **Different technical characteristic can be considered, under specific requests**

1CORFP10

1CORFP20

The selection of the required output is achieved by adjusting the minidip keys as described in the following diagram: where a Voltage output is required connection is by terminal Nos, 13 and 15 and for Current output connect to terminal Nos, 13 and 14. The auxiliary Power Supply is achieved by: use terminal 22 as the common connection; for 230V connect to Terminal 23; for 400V connect to Terminal 24

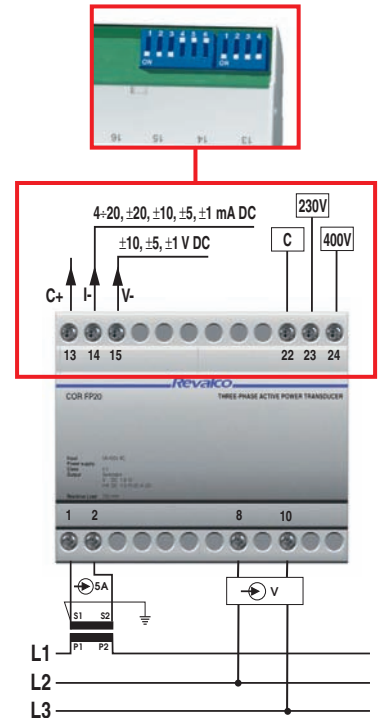
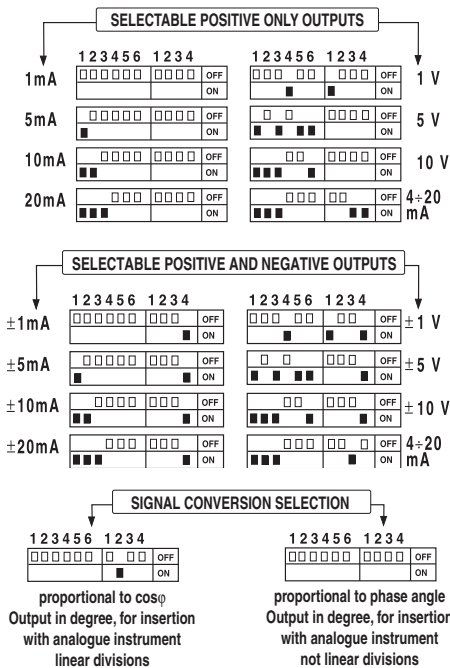
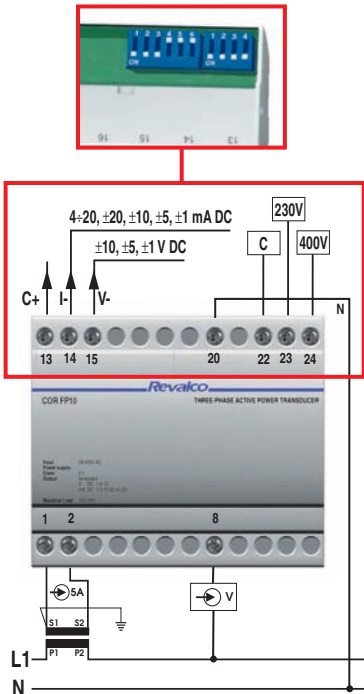

FREQUENCY TRANSDUCERS

1CORF

- **AUXILIARY SUPPLY (separate)**
- **NOMINAL INPUT VALUES VOLTAGE**
- **NOMINAL OUTPUT VALUES (selectable)**
- **RESISTIVE LOAD / ACCURACY CLASS**
- **MEASURING RANGE**
- **OVERLOAD**
- **RESPONSE TIME / ALTERNATED RESIDUAL**
- **BURDEN**
- **GALVANIC SEPARATION BETWEEN INPUTS AND OUTPUTS**

230V AC standard
 100V \div 500V AC
 1 - 5 - 10 - VDC and 1 - 5 - 10 - 20 - 4/20 mA DC
 700 Ω / 0,5
 45 / 65 Hz standard (other on request)
Permanent: 1,2 Un **Instantaneous:** 2 Un for 1 sec.
 ≤ 300 ms / $\leq 1\%$
 voltage ≤ 1 VA power supply ≤ 4 VVA

- **OPERATING TEMPERATURE / INPUT WAVE FORM** 0 °C \div +55 °C / OS - OQ - OSP
- **DIMENSIONS / WEIGHT Kg.** 3 DIN modules / 0,25
- **Different technical characteristic can be considered, under specific requests**

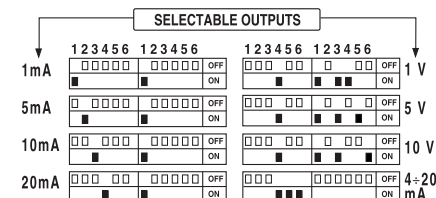

The selection of the required output is achieved by adjusting the minidip keys as described in the diagram.

Where a Voltage output is required connection is by terminal Nos, 7 and 8 and for Current output connect to terminal Nos, 11 and 12

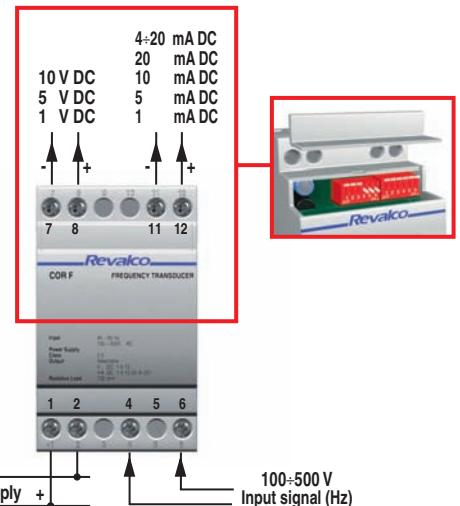

SINGLE PHASE ACTIVE AND REACTIVE POWER TRANSDUCERS

1CORPA10 / 1CORPR10 - 1CORPA10485 / 1CORPR10485

These transducers have the galvanic separation between inputs and outputs, and have the capability to offer multiple choice auxiliary supply of (230V, 400V) by terminal selection and 8 Outputs (1-10 VDC and 1-5-10-20-4/20 mA DC), by minidip key located under a removable section of the upper case wall and by terminal selection.

The standard calibration is: 100V, 5A = 500 W (var) 230V, 5A = 1000 W (var) 400V, 5A = 2000 W (var)

Active Power Reactive Power

- SELECTABLE BIDIRECTIONAL OUTPUTS
- SELECTABLE BIDIRECTIONAL OUTPUTS WITH SERIAL OUTPUT RS485
- MODBUS SLAVE RTU PROTOCOL
- INPUT WAVE FORM
- NOMINAL OUTPUT VALUES (selectable)
- AUXILIARY SUPPLY (separate)
- NOMINAL INPUT VALUES
- RESISTIVE LOAD / MEASURING RANGE
- STANDARD CALIBRATION
- ACCURACY CLASS / OPERATING FREQUENCY
- OVERLOAD
- RESPONSE TIME / ALTERNATED RESIDUAL
- BURDEN
- GALVANIC SEPARATION BETWEEN INPUTS AND OUTPUTS
- OPERATING TEMPERATURE / DIMENSIONS / WEIGHT Kg.

1CORPA10
1CORPR10

1CORPA10485
1CORPR10485

OS - OSD (schemes D10, D2)
 $\pm 1, \pm 5, \pm 10$ VDC and $\pm 1, \pm 5, \pm 10, \pm 20, 4/20$ mADC
 230V / 400V AC standard
 voltage: 230V standard - current: 5A (1A on request)
 700Ω max / $0 \div P_n$ ($0 \div Q_n$)
 100V,5A=500W (var) 230V,5A=1000W (var) 400V,5A=2000W (var)
 $0,5 / 50 - 60$ Hz
Permanent: $2 I_n / 1,2 U_n$ **Instantaneous:** $10 I_n / 2 U_n$ for 1 sec.
 ≤ 300 ms / $\leq 1\%$
 voltage circuit ≤ 1 VA current circuit $\leq 0,8$ VVA power supply ≤ 4 VVA
 insulation between the all circuits and earth 4kV for 1min at 50Hz
 $0^\circ\text{C} \div +55^\circ\text{C} / 6$ DIN modules / $0,50$

! Different technical characteristic can be considered, under specific requests.
 The software is available, free of charge, on our internet address www.revalco.it

1CORPA10 / 1CORPA10485 - 1CORPR10 / 1CORPR10485

The selection of the required output is achieved by adjusting the minidip keys as described in the following diagram:

where a Voltage output is required connection is by terminal Nos, 13 and 15 and for Current output connect to terminal Nos, 13 and 14.

The auxiliary Power Supply is achieved by: use terminal 22 as the common connection; for 230V connect to Terminal 23; for 400V connect to Terminal 24

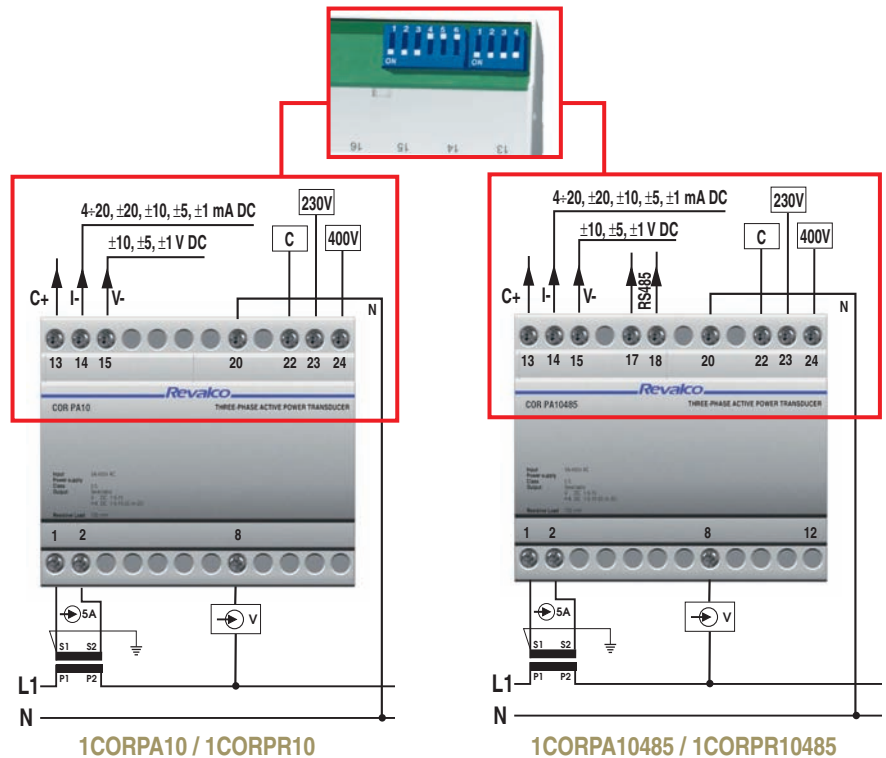
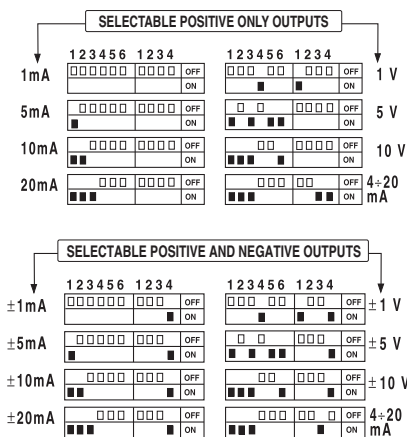

THREE PHASE ACTIVE OR REACTIVE POWER TRANSDUCERS

These transducers have the galvanic separation between inputs and outputs, and have the capability to offer multiple choice auxiliary supply of (230V, 400V) by terminal selection and 8 Outputs (1-5-10 VDC and 1-5-10-20-4/20 mA DC), by minidip key located under a removable section of the upper case wall and by terminal selection. The standard calibration is: 100V, 5A = 1000 W (var) 230V, 5A = 2000 W (var) 400V, 5A = 4000 W (var)

Active Power
Reactive Power

- SELECTABLE BIDIRECTIONAL OUTPUTS
- SELECTABLE BIDIRECTIONAL OUTPUTS WITH SERIAL OUTPUT RS485
- MODBUS SLAVE RTU PROTOCOL
- INPUT WAVE FORM
- NOMINAL OUTPUT VALUES (selectable)
- AUXILIARY SUPPLY (separate)
- NOMINAL INPUT VALUES
- RESISTIVE LOAD / MEASURING RANGE
- STANDARD CALIBRATION
- ACCURACY CLASS / OPERATING FREQUENCY
- OVERLOAD
- RESPONSE TIME / ALTERNATED RESIDUAL
- BURDEN
- GALVANIC SEPARATION BETWEEN INPUTS AND OUTPUTS
- OPERATING TEMPERATURE / DIMENSIONS / WEIGHT Kg.

Balanced load
3 wires without neutral

1CORPA20 1CORPA20485
1CORPR20 1CORPR20485

Unbalanced load
3 wires with neutral (Aron)

1CORPA30 1CORPA30485
1CORPR30 1CORPR30485

OS - OSD (schemes D10, D2)
±1, ±5, ±10 VDC and ±1, ±5, ±10, ±20, 4/20 mADC
230V / 400V AC standard
voltage: 400V standard - current: 5A (1A on request)
700Ω max / 0 ÷ Pn (0 ÷ Qn)
100V,5A=1000W (var) 230V,5A=2000W (var) 400V,5A=4000W (var)
0,5 / 50 - 60 Hz
Permanent: 2 In / 1,2 Un **Instantaneous:** 10 In / 2 Un for 1 sec.
≤ 300 ms / ≤ 1%
voltage circuit ≤ 1VA current circuit ≤ 0,8VA power supply ≤ 4VA
insulation between inputs, outputs, power supply 2kV for 1min at 50Hz
insulation between the all circuits and earth 4kV for 1min at 50Hz
0 °C ÷ +55 °C / 6 DIN modules / 0,50

 Different technical characteristic can be considered, under specific requests. The software is available, free of charge, on our internet address www.revalco.it

CONNECTION DIAGRAMS

The selection of the required output is achieved by adjusting the minidip keys as described in the following diagram: where a Voltage output is required connection is by terminal Nos, 13 and 15 and for Current output connect to terminal Nos, 13 and 14. The auxiliary Power Supply is achieved by: use terminal 22 as the common connection; for 230V connect to Terminal 23; for 400V connect to Terminal 24

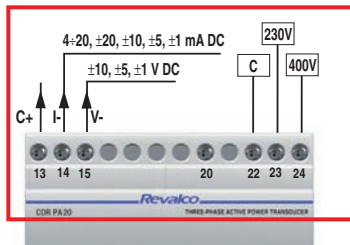
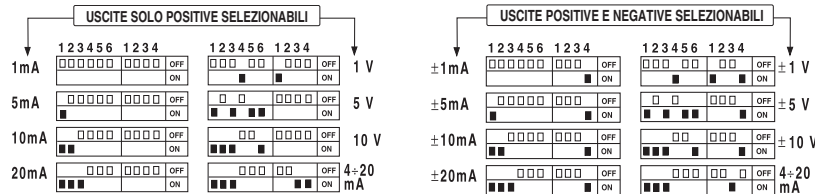

1CORPA20
1CORPR20

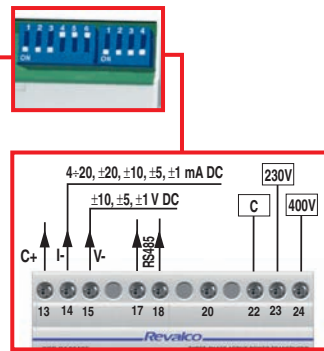

1CORPA20485
1CORPR20485

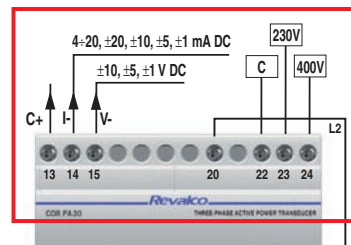

1CORPA30
1CORPR30

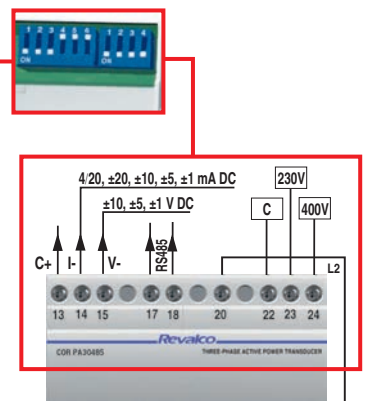

1CORPA30485
1CORPR30485

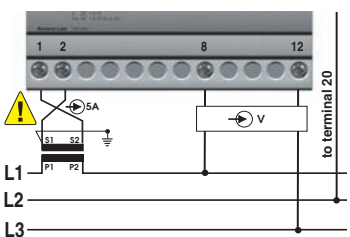

1CORPR20
1CORPR20485

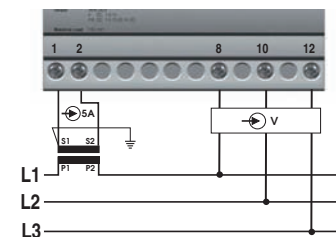

1CORPA20
1CORPA20485

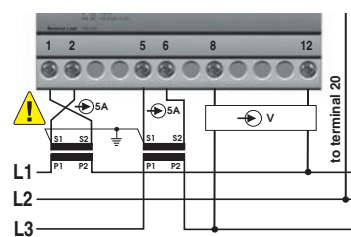

1CORPR30
1CORPR30485

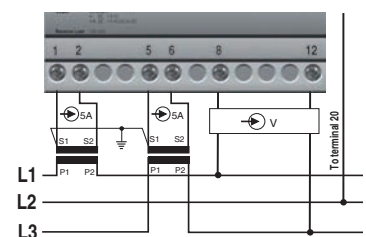

1CORPA30
1CORPA30485

THREE PHASE ACTIVE OR REACTIVE POWER TRANSDUCERS

These transducers have the galvanic separation between inputs and outputs, and have the capability to offer multiple choice auxiliary supply of (230V, 400V) by terminal selection and 8 Outputs (1-5-10 VDC and 1-5-10-20-4/20 mA DC), by minidip key located under a removable section of the upper case wall and by terminal selection. The standard calibration is: 100V, 5A = 1000 W (var) 230V, 5A = 2000 W (var) 400V, 5A = 4000 W (var)

- Active Power**
Reactive Power
- SELECTABLE BIDIRECTIONAL OUTPUTS
 - SELECTABLE BIDIRECTIONAL OUTPUTS WITH SERIAL OUTPUT RS485
 - MODBUS SLAVE RTU PROTOCOL
 - INPUT WAVE FORM
 - NOMINAL OUTPUT VALUES (selectable)
 - AUXILIARY SUPPLY (separate)
 - NOMINAL INPUT VALUES
 - RESISTIVE LOAD / MEASURING RANGE
 - STANDARD CALIBRATION
 - ACCURACY CLASS / OPERATING FREQUENCY
 - OVERLOAD
 - RESPONSE TIME / ALTERNATED RESIDUAL
 - BURDEN
 - GALVANIC SEPARATION BETWEEN INPUTS AND OUTPUTS
 - OPERATING TEMPERATURE / DIMENSIONS / WEIGHT Kg.

Balanced load
4 wires with neutral

1CORPA40 1CORPA40485
1CORPR40 1CORPR40485

Unbalanced load
4 wires with neutral

1CORPA50 1CORPA50485
1CORPR50 1CORPR50485

OS - OSD (schemes D10, D2)
±1, ±5, ±10 VDC and ±1, ±5, ±10, ±20, 4/20 mA DC
230V / 400V AC standard
voltage: 400V standard - current: 5A (1A on request)
700Ω max / 0 ÷ Pn (0 ÷ Qn)
100V,5A=1000W (var) 230V,5A=2000W (var) 400V,5A=4000W (var)
0,5 / 50 - 60 Hz
Permanent: 2 In / 1,2 Un **Instantaneous:** 10 In / 2 Un for 1 sec.
≤ 300 ms / ≤ 1%
voltage circuit ≤ 1VA current circuit ≤ 0,8VA power supply ≤ 4VA
insulation between inputs, outputs, power supply 2kV for 1min at 50Hz
insulation between the all circuits and earth 4kV for 1min at 50Hz
0 °C ÷ +55 °C / 6 DIN modules / 0,50

 Different technical characteristic can be considered, under specific requests. The software is available, free of charge, on our internet address www.revalco.it

CONNECTION DIAGRAMS

The selection of the required output is achieved by adjusting the minidip keys as described in the following diagram: where a Voltage output is required connection is by terminal Nos, 13 and 15 and for Current output connect to terminal Nos, 13 and 14. The auxiliary Power Supply is achieved by: use terminal 22 as the common connection; for 230V connect to Terminal 23; for 400V connect to Terminal 24

