



KRAUS & NAIMER

BLUE LINE Load Break Switch V4.2

www.krausnaimer.com

SINCE 1907

16 - 1250 Ampere



Type KG/KH Load Break Switch

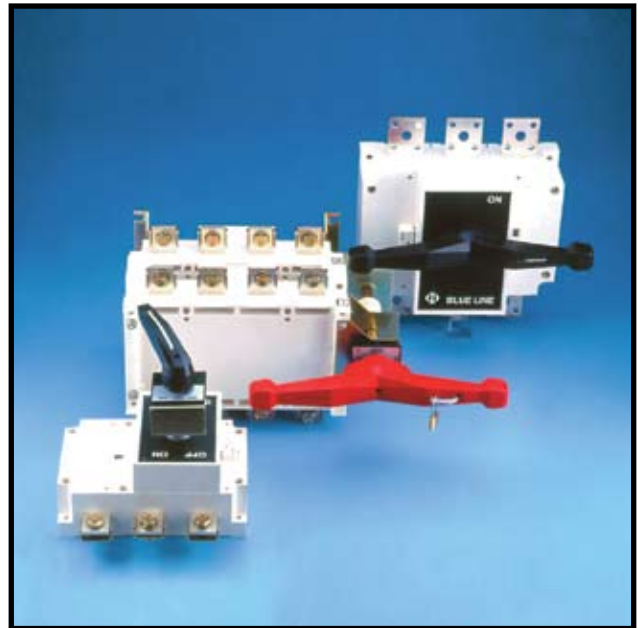









Type KF Load Break Switch



Enclosed switch in thermoplastic KL/KS enclosures















Enclosed switch in metal & thermoplastic enclosures

 MAIN SWITCH 	RATING lth2	 3P	 3P + N
Panel Mounting - Type E ¹¹⁾ 	16A 20A 25A 32A 40A 63A 80A 100A 125A 160A 200A 250A 315A	KH16B T303/SGZ621E KH20B T303/SGZ621E KG20B T303/SGZ621E KG32B T303/SGZ621E KG41B T303/SGZ621E KH63 T303/SGZ621E KG80 T303/SGZ621E KG100 T303/SGZ621E KG105 T303/SGY621E KG161 T303/SGY621E KG211 T303/SGY621E KG251 T303/SGY621E KG316 T303/SGY621E	KH16B T307/SGZ621E KH20B T307/SGZ621E KG20B T307/SGY621E KG32B T307/SGY621E KG41B T307/SGY621E KH63 T307/SGY621E KG80 T307/SGY621E KG100 T307/SGY621E KG105 T307/SGY621E KG161 T307/SGY621E KG211 T307/SGY621E KG251 T307/SGY621E KG316 T307/SGY621E
Base Mounting - Type VE2 (with padlockable handle V840B) 	25A 32A 40A 63A 80A 100A 125A 160A	KG20A T203/SGY004VE2 KG32A T203/SGY004VE2 KG41 T203/SGZ004VE2 KH63 T203/SGY004VE2 KG80 T203/SGY004VE2 KG100 T203/SGY004VE2 KG105 T203/SGY004VE2 KG161 T103/SGY004VE2	KG20A T207/SGY004VE2 KG32A T207/SGY004VE2 KG41 T207/SGY004VE2 KH63 T207/SGY004VE2 KG80 T207/SGY004VE2 KG100 T207/SGY004VE2 KG105 T207/SGY004VE2 KG161 T107/SGY004VE2
Base Mounting - Type VE ¹¹⁾ (with Door Interlock) 	16A 20A 25A 32A 40A 63A 80A 100A 125A 160A 200A 250A 315A 400A 630A 800A 1250A	KH16B T303/SGZ001VE KH20B T303/SGZ001VE KG20B T303/SGZ001VE KG32B T303/SGZ001VE KG41B T303/SGZ001VE KH63 T303/SGZ001VE KG 80 T303/SGZ001VE KG100 T303/SGZ001VE KG105 T303/SGZ001VE KG161 T303/SGZ001VE KG211 T303/SGZ001VE KG251 T303/SGZ001VE KG316 T303/SGZ001VE 930S KF401K300 SIS1* 930S KF631K300 SIS1* 930S KF800K300 SIS1* 930S KF1250K300 SIS1*	KH16B T307/SGY001VE KH20B T307/SGY001VE KG20B T307/SGY001VE KG32B T307/SGY001VE KG41B T307/SGY001VE KH63 T307/SGY001VE KG 80 T307/SGY001VE KG100 T307/SGY001VE KG105 T307/SGY001VE KG161 T307/SGY001VE KG211 T307/SGY001VE KG251 T307/SGY001VE KG316 T307/SGY001VE - - - -
Base Mounting - Type VE ¹¹⁾ (with Door Interlock/Padlockable Handle) 	16A 20A 25A 32A 40A 63A 80A 100A 125A 160A 200A 250A 315A	KH16B T203/SGZ002VE KH20B T203/SGZ002VE KG20B T203/SGZ002VE KG32B T203/SGZ002VE KG41B T203/SGZ002VE KH63 T203/SGZ002VE KG 80 T203/SGZ002VE KG100 T203/SGZ002VE KG105 T103/SGZ002VE KG161 T103/SGZ002VE KG211 T103/SGZ002VE KG251 T103/SGZ002VE KG316 T103/SGZ002VE	KH16B T207/SGY002VE KH20B T207/SGY002VE KG20B T207/SGY002VE KG32B T207/SGY002VE KG41B T207/SGY002VE KH63 T207/SGY002VE KG 80 T207/SGY002VE KG100 T207/SGY002VE KG105 T107/SGY002VE KG161 T107/SGY002VE KG211 T107/SGY002VE KG251 T107/SGY002VE KG316 T107/SGY002VE

¹¹⁾ Front protection IP40 Dust/Damp Proof. IP65 Dust/ Damp Proof available on request.

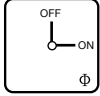
*Fitted with Black handle. For Red handle order as SIS2.

 4P	 6P	 8P	 3P	 4P
KH16B T304/SGZ621E KH20B T304/SGZ621E KG20B T304/SGZ621E KG32B T304/SGZ621E KG41B T304/SGZ621E KH63 T304/SGZ621E KG80 T304/SGZ621E KG100 T304/SGZ621E KG105 T304/SGY621E KG161 T304/SGY621E KG211 T304/SGY621E KG251 T304/SGY621E KG316 T304/SGY621E	- - KG20B T306/SGY621E KG32B T306/SGY621E KG41B T306/SGY621E - KG80C T306/SGY621E KG100C T306/SGY621E KG105C T306/SGY621E KG161 T306/SGY621E - - -	- - KG20B T308/SGY621E KG32B T308/SGY621E KG41B T308/SGY621E - KG80C T308/SGY621E KG100C T308/SGY621E KG105C T308/SGY621E KG161 T308/SGY621E	- - KG20B T903/SGY620E KG32B T903/SGY620E KG41B T903/SGY620E - KG80C T903/SGY620E KG100C T903/SGY620E KG105C T903/SGY620E KG162 T903/SGY620E - - -	- - KG20B T904/SGY620E KG32B T904/SGY620E KG41B T904/SGY620E - KG80C T904/SGY620E KG100C T904/SGY620E KG105C T904/SGY620E KG162 T904/SGY620E - - -
KG20A T204/SGY004VE2 KG32A T204/SGY004VE2 KG41 T204/SGY004VE2 KH63 T204/SGY004VE2 KG80 T204/SGY004VE2 KG100 T204/SGY004VE2 KG105 T204/SGY004VE2 KG161 T104/SGY004VE2	KG20A T206/SGY004VE2 KG32A T206/SGY004VE2 KG41B T206/SGY004VE2 - - - - -	- - - - - - -	KG20A T903/SGY004VE2 KG32A T903/SGY004VE2 KG41B T903/SGY004VE2 - - - - -	KG20A T904/SGY004VE2 KG32A T904/SGY004VE2 KG41B T904/SGY004VE2 - - - - -
KH16B T304/SGZ001VE KH20B T304/SGZ001VE KG20B T304/SGZ001VE KG32B T304/SGZ001VE KG41B T304/SGZ001VE KH63 T304/SGZ001VE KG 80 T304/SGZ001VE KG100 T304/SGZ001VE KG105 T304/SGZ001VE KG161 T304/SGZ001VE KG211 T304/SGZ001VE KG251 T304/SGZ001VE KG316 T304/SGZ001VE 930S KF401K400 SIS1* 930S KF631K400 SIS1* 930S KF800K400 SIS1* 930S KF1250K400 SIS1*	- - KG20B T306/SGY001VEB KG32B T306/SGY001VEB KG41B T306/SGY001VE KG64B T306/SGY001VE KG80C T306/SGY001VE KG100C T306/SGY001VE KG105C T306/SGY001VE KG161 T306/SGY001VE - - - - - - - - -	- - KG20B T308/SGY001VEB KG32B T308/SGY001VEB KG41B T308/SGY001VE KG64B T308/SGY001VE KG80C T308/SGY001VE KG100C T308/SGY001VE KG105C T308/SGY001VE KG161 T308/SGY001VE - - - - - - - -	- - KG20B T903/SGZ001VEB KG32B T903/SGZ001VEB KG41B T903/SGZ001VE KG64B T903/SGZ001VE KG80C T903/SGZ001VE KG100C T903/SGZ001VE KG105C T903/SGZ001VE KG162 T903/SGZ001VE - - - - - - - -	- - KG20B T904/SGZ001VEB KG32B T904/SGZ001VEB KG41B T904/SGZ001VE KG64B T904/SGZ001VE KG80C T904/SGZ001VE KG100C T904/SGZ001VE KG105C T904/SGZ001VE KG162 T904/SGZ001VE - 930S KF252K950 SIS1* - 930S KF402K950 SIS1* 930S KF632 K950 SIS1* 930S KF802K950 SIS1* 930S KF1252K950 SIS1*
KH16B T204/SGY002VE KH20B T204/SGY002VE KG20B T204/SGY002VE KG32B T204/SGY002VE KG41B T204/SGY002VE KH63 T204/SGY002VE KG 80 T204/SGY002VE KG100 T204/SGY002VE KG105 T104/SGY002VE KG161 T104/SGY002VE KG211 T104/SGY002VE KG251 T104/SGY002VE KG316 T104/SGY002VE	- - KG20B T206/SGZ002VEB KG32B T206/SGZ002VEB KG41B T206/SGZ002VE KG64B T206/SGZ002VE KG80C T206/SGZ002VE KG100C T206/SGZ002VE KG105C T106/SGY002VE KG161 T106/SGY002VE - - -	- - KG20B T208/SGZ002VEB KG32B T208/SGZ002VEB KG41B T208/SGZ002VE KG64B T208/SGZ002VE KG80C T208/SGZ002VE KG100C T208/SGZ002VE KG105C T108/SGY002VE KG161 T108/SGY002VE - - -	- - KG20B T903/SGY002VEB KG32B T903/SGY002VEB KG41B T903/SGY002VE KG64B T903/SGY002VE KG80C T903/SGY002VE KG100C T903/SGY002VE KG105C T903/SGY002VE KG162 T903/SGY002VE - - -	- - KG20B T904/SGY002VEB KG32B T904/SGZ002VEB KG41B T904/SGZ002VE KG64B T904/SGZ002VE KG80C T904/SGZ002VE KG100C T904/SGZ002VE KG105C T904/SGY002VE KG162 T904/SGY002VE - - -

 MAINTENANCE & SAFETY SWITCH 	RATING lth ₂	 2P + E	 3P + E
<p>Thermoplastic Enclosed Switch Weather-proof IP65 *Weather-proof IP66/67</p> 	16A 20A 25A 32A 40A 63A ¹²⁾ 63A ¹³⁾ 80A 100A 125A 160A 200A 250A 315A 400A 630A 800A 1250A	- - *KG20 T202/SGZ003*KS2V *KG32 T202/SGZ003*KL2V - - - - - - - - - - - - - - - - - - -	*KH16 T200/SGZ003*KS2V *KH20 T200/SGZ003*KS2V *KG20 T203/SGZ003*KS2V *KG32 T203/SGZ003*KL2V *KG41 T203/SGZ003*KL2V *KG64 T203/SGZ003*KL2V *KH63 T200/SGZ003*KL2V *KG80 T203/SGZ003*KL2V KG100 T203/SGY003*9P65 KG105 T103/SGY003*9P65 KG161 T103/SGY003*9P65 KG211 T103/SGY003*9P65 KG251 T103/SGY003*9P65 KG316 T103/SGY003*9P65 930S KF401K300P65 SIS1 930S KF631K300P65 SIS1 930S KF800K300P65 SIS1 930S KF1250K300P65 SIS1
<p>Sheet Steel Enclosed Switch General Purpose IP40</p> 	16A 20A 25A 32A 40A 63A 80A 100A 125A 160A 200A 250A 315A 400A 630A 800A	- - KG20B T202/SG2107*9M40 KG32B T202/SG2107*9M40 KG41B T202/SGY005*9M40 - - - - - - - - - - - - - - - - - - -	KH16B T203/SG2107*9M40 KH20B T203/SG2107*9M40 KG20B T203/SGY005*9M40 KG32B T203/SGY005*9M40 KG41B T203/SGY005*9M40 KH63 T203/SG2133*9M40 KG80 T203/SGY005*9M40 KG100 T203/SGY005*9M40 KG105 T103/SGY005*9M40 KG161 T103/SGY005*9M40 KG211 T103/SGY005*9M40 KG251 T103/SGY005*9M40 KG316 T103/SGY005*9M40 930S KF401K300M40 SIS1 930S KF631K300M40 SIS1 930S KF800K300M40 SIS1
<p>Sheet Steel Enclosed Switch Dust/Damp Proof IP55</p> 	40A 63A 80A 100A 125A 160A 200A 250A 315A 400A 630A 800A 1250A	- -	KG41B T203/SGY009*9M55 KH63 T203/SGY009*9M55 KG80 T203/SGY009*9M55 KG100 T203/SGY009*9M55 KG105 T103/SGY009*9M55 KG161 T103/SGY009*9M55 KG211 T103/SGY009*9M55 KG251 T103/SGY009*9M55 KG316 T103/SGY009*9M55 930S KF401K300M55 SIS1 930S KF631K300M55 SIS1 930S KF800K300M55 SIS1 930S KF1250K300M55 SIS1
<p>Stainless Steel Enclosed Switch Dust/Damp Proof IP65</p> 	40A 63A 80A 100A 125A 160A 200A 250A 315A 400A 630A 800A	- - - - - - - - - - - - - - - - - - - -	KG41B T203/SGY010*9S65 KH63 T203/SGY010*9S65 KG 80 T203/SGY010*9S65 KG100 T203/SGY010*9S65 KG105 T103/SGY010*9S65 KG161 T103/SGY010*9S65 KG211 T103/SGY010*9S65 KG251 T103/SGY010*9S65 KG316 T103/SGY010*9S65 930S KF401K300S65 SIS1 930S KF631K300S65 SIS1 930S KF800K300S65 SIS1

12) KG64 - suitable for cable size up to 16mm²
 13) KH63 - suitable for cable size up to 35mm²

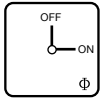

3P + N + E

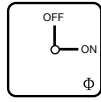

4P + E

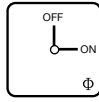

6P

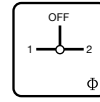

3P

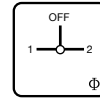

4P

<p>*KH16 T207/SGZ003*KS2V</p> <p>*KH20 T207/SGZ003*KS2V</p> <p>*KG20 T203/SGZ003*KS2V</p> <p>*KG32 T203/SGZ003*KL2V</p> <p>*KG41 T203/SGZ003*KL2V</p> <p>*KG64 T203/SGZ003*KL2V</p> <p>*KH63 T207/SGZ003*KL2V</p> <p>*KG80 T203/SGZ003*KL2V</p> <p>KG100 T205/SGZ003*9P65</p> <p>KG105 T105/SGZ003*9P65</p> <p>KG161 T105/SGZ003*9P65</p> <p>KG211 T105/SGZ003*9P65</p> <p>KG251 T105/SGZ003*9P65</p> <p>KG316 T105/SGZ003*9P65</p> <p>930S KF401K300P65 SIS2</p> <p>930S KF631K300P65 SIS2</p> <p>930S KF800K300P65 SIS2</p> <p>930S KF1250K300P65 SIS2</p>	<p>*KH16 T204/SGY003*KS2V</p> <p>*KH20 T204/SGY003*KS2V</p> <p>*KG20 T204/SGY003*KS2V</p> <p>*KG32 T204/SGY003*KL2V</p> <p>*KG41 T204/SGY003*KL2V</p> <p>*KG64 T204/SGY003*KL2V</p> <p>*KH63 T204/SGY003*KL2V</p> <p>*KG80 T204/SGY003*KL2V</p> <p>KG100 T204/SGY003*9P65</p> <p>KG105 T104/SGY003*9P65</p> <p>KG161 T104/SGY003*9P65</p> <p>KG211 T104/SGY003*9P65</p> <p>KG251 T104/SGY003*9P65</p> <p>KG316 T104/SGY003*9P65</p> <p>930S KF401K400P65 SIS1</p> <p>930S KF631K400P65 SIS1</p> <p>930S KF800K400P65 SIS1</p> <p>930S KF1250K400P65 SIS1</p>	<p>-</p> <p>-</p> <p>KG20B T206/SGY003*9P65</p> <p>KG32B T206/SGY003*9P65</p> <p>KG41B T206/SGY003*9P65</p> <p>KG64B T206/SGY003*9P65</p> <p>-</p> <p>KG80C T206/SGY003*9P65</p> <p>KG100C T206/SGY003*9P65</p> <p>KG105C T106/SGY003*9P65</p> <p>KG161 T106/SGY003*9P65</p> <p>-</p> <p>-</p> <p>-</p> <p>-</p> <p>-</p> <p>-</p> <p>-</p> <p>-</p> <p>-</p> <p>-</p> <p>-</p>	<p>-</p> <p>-</p> <p>KG20B T903/SGY003*9P65</p> <p>KG32B T903/SGY003*9P65</p> <p>KG41B T903/SGY003*9P65</p> <p>KG64B T903/SGY003*9P65</p> <p>-</p> <p>KG80C T903/SGY003*9P65</p> <p>KG100C T903/SGY003*9P65</p> <p>KG105C T903/SGY003*9P65</p> <p>KG162 T903/SGY003*9P65</p> <p>-</p> <p>-</p> <p>-</p> <p>-</p> <p>-</p> <p>-</p> <p>-</p> <p>-</p> <p>-</p>	<p>-</p> <p>-</p> <p>KG20B T904/SGY003*9P65</p> <p>KG32B T904/SGY003*9P65</p> <p>KG41B T904/SGY003*9P65</p> <p>KG64B T904/SGY003*9P65</p> <p>-</p> <p>KG80C T904/SGY003*9P65</p> <p>KG100C T904/SGY003*9P65</p> <p>KG105C T904/SGY003*9P65</p> <p>KG162 T904/SGY003*9P65</p> <p>-</p> <p>930S KF252K950P65 SIS1</p> <p>-</p> <p>930S KF402K950P65 SIS1</p> <p>930S KF632K950P65 SIS1</p> <p>-</p> <p>-</p> <p>-</p>
<p>KH16B T207/SG2107*9M40</p> <p>KH20B T207/SG2107*9M40</p> <p>KG20B T207/SG2107*9M40</p> <p>KG32B T207/SG2107*9M40</p> <p>KG41B T207/SG2131*9M40</p> <p>KH63 T207/SG2133*9M40</p> <p>KG80 T203/SGC800*9M40</p> <p>KG100 T207/SG2110*9M40</p> <p>KG105 T107/SGZ005*9M40</p> <p>KG161 T107/SGZ005*9M40</p> <p>KG211 T107/SGZ005*9M40</p> <p>KG251 T107/SGZ005*9M40</p> <p>KG316 T107/SGZ005*9M40</p> <p>930S KF401K300M40 SIS2</p> <p>930S KF631K300M40 SIS2</p> <p>930S KF800K300M40 SIS2</p>	<p>KH16B T204/SGY005*9M40</p> <p>KH20B T204/SGY005*9M40</p> <p>KG20B T204/SGY005*9M40</p> <p>KG32B T204/SGY005*9M40</p> <p>KG41B T204/SGY005*9M40</p> <p>KH63 T204/SGY005*9M40</p> <p>KG80 T204/SGY005*9M40</p> <p>KG100 T204/SGY005*9M40</p> <p>KG105 T104/SGY005*9M40</p> <p>KG161 T104/SGY005*9M40</p> <p>KG211 T104/SGY005*9M40</p> <p>KG251 T104/SGY005*9M40</p> <p>KG316 T104/SGY005*9M40</p> <p>930S KF401K400M40 SIS1</p> <p>930S KF631K400M40 SIS1</p> <p>930S KF800K400M40 SIS1</p>	<p>-</p> <p>-</p> <p>-</p> <p>-</p> <p>-</p> <p>-</p> <p>-</p> <p>-</p> <p>-</p> <p>-</p> <p>-</p> <p>-</p> <p>-</p> <p>-</p> <p>-</p> <p>-</p> <p>-</p>	<p>-</p> <p>-</p> <p>-</p> <p>-</p> <p>-</p> <p>-</p> <p>-</p> <p>-</p> <p>-</p> <p>-</p> <p>-</p> <p>-</p> <p>-</p> <p>-</p> <p>-</p> <p>-</p> <p>-</p>	<p>-</p> <p>-</p> <p>-</p> <p>-</p> <p>-</p> <p>-</p> <p>-</p> <p>-</p> <p>-</p> <p>-</p> <p>-</p> <p>-</p> <p>-</p> <p>-</p> <p>-</p> <p>-</p> <p>-</p>
<p>KG41B T207/SGY009*9M55</p> <p>KH63 T207/SGY009*9M55</p> <p>KG 80 T207/SGY009*9M55</p> <p>KG100 T207/SGY009*9M55</p> <p>KG105 T107/SGY009*9M55</p> <p>KG161 T107/SGY009*9M55</p> <p>KG211 T107/SGY009*9M55</p> <p>KG251 T107/SGY009*9M55</p> <p>KG316 T107/SGY009*9M55</p> <p>930S KF401K300M55 SIS2</p> <p>930S KF631K300M55 SIS2</p> <p>930S KF800K300M55 SIS2</p> <p>930S KF1250K300M55 SIS2</p>	<p>KG41B T204/SGY009*9M55</p> <p>KH63 T204/SGY009*9M55</p> <p>KG 80 T204/SGY009*9M55</p> <p>KG100 T204/SGY009*9M55</p> <p>KG105 T104/SGY009*9M55</p> <p>KG161 T104/SGY009*9M55</p> <p>KG211 T104/SGY009*9M55</p> <p>KG251 T104/SGY009*9M55</p> <p>KG316 T104/SGY009*9M55</p> <p>930S KF401K400M55 SIS1</p> <p>930S KF631K400M55 SIS1</p> <p>930S KF800K400M55 SIS1</p> <p>930S KF1250K400M55 SIS1</p>	<p>KG41B T206/SGY009*9M55</p> <p>-</p> <p>KG80C T206/SGY009*9M55</p> <p>KG100C T206/SGY009*9M55</p> <p>KG105C T106/SGY009*9M55</p> <p>KG161 T106/SGY009*9M55</p> <p>-</p> <p>-</p> <p>-</p> <p>-</p> <p>-</p> <p>-</p> <p>-</p> <p>-</p>	<p>KG41B T903/SGY009*9M55</p> <p>-</p> <p>KG80C T903/SGY009*9M55</p> <p>KG100C T903/SGY009*9M55</p> <p>KG105C T903/SGY009*9M55</p> <p>KG162 T903/SGY009*9M55</p> <p>-</p> <p>-</p> <p>-</p> <p>-</p> <p>-</p> <p>-</p> <p>-</p>	<p>KG41B T904/SGY009*9M55</p> <p>-</p> <p>KG80C T904/SGY009*9M55</p> <p>KG100C T904/SGY009*9M55</p> <p>KG105C T904/SGY009*9M55</p> <p>KG162 T904/SGY009*9M55</p> <p>-</p> <p>930S KF252K950M55 SIS1</p> <p>-</p> <p>930S KF402K950M55 SIS1</p> <p>930S KF632K950M55 SIS1</p> <p>930S KF802K950M55 SIS1</p> <p>930S KF1252K950M55 SIS1</p>
<p>KG41B T207/SGY010*9S65</p> <p>KH63 T207/SGY010*9S65</p> <p>KG 80 T207/SGY010*9S65</p> <p>KG100 T207/SGY010*9S65</p> <p>KG105 T107/SGY010*9S65</p> <p>KG161 T107/SGY010*9S65</p> <p>KG211 T107/SGY010*9S65</p> <p>KG251 T107/SGY010*9S65</p> <p>KG316 T107/SGY010*9S65</p> <p>930S KF401K300S65 SIS2</p> <p>930S KF631K300S65 SIS2</p> <p>930S KF800K300S65 SIS2</p>	<p>KG41B T204/SGY010*9S65</p> <p>KH63 T204/SGY010*9S65</p> <p>KG 80 T204/SGY010*9S65</p> <p>KG100 T204/SGY010*9S65</p> <p>KG105 T104/SGY010*9S65</p> <p>KG161 T104/SGY010*9S65</p> <p>KG211 T104/SGY010*9S65</p> <p>KG251 T104/SGY010*9S65</p> <p>KG316 T104/SGY010*9S65</p> <p>930S KF401K400S65 SIS1</p> <p>930S KF631K400S65 SIS1</p> <p>930S KF800K400S65 SIS1</p>	<p>-</p> <p>KG41B T206/SGY010*9S65</p> <p>KG80C T206/SGY010*9S65</p> <p>KG100C T206/SGY010*9S65</p> <p>KG105C T106/SGY010*9S65</p> <p>KG161 T106/SGY010*9S65</p> <p>-</p> <p>-</p> <p>-</p> <p>-</p> <p>-</p> <p>-</p> <p>-</p>	<p>-</p> <p>KG41B T903/SGY010*9S65</p> <p>KG80C T903/SGY010*9S65</p> <p>KG100C T903/SGY010*9S65</p> <p>KG105C T903/SGY010*9S65</p> <p>KG162 T903/SGY010*9S65</p> <p>-</p> <p>-</p> <p>-</p> <p>-</p> <p>-</p> <p>-</p> <p>-</p>	<p>-</p> <p>KG41B T904/SGY010*9S65</p> <p>KG80C T904/SGY010*9S65</p> <p>KG100C T904/SGY010*9S65</p> <p>KG105C T904/SGY010*9S65</p> <p>KG162 T904/SGY010*9S65</p> <p>-</p> <p>-</p> <p>-</p> <p>-</p> <p>-</p> <p>-</p> <p>-</p>



IP65/IP66 Thermoplastic Enclosed Switch ON-OFF

Switch Rating	Number of Poles	Cable Size mm ²	Switch Reference		Enclosure Type	Enclosure Dimension (mm)			Mounting Dimension (mm)				Entries Dimension	
						A	B	H	E	F	C	D10	D20	D30
25A	2P+E	6.0	KG20	T202/SGZ003*KS2V	KS2V	120	85	80	-	-	110	4.0	23	19
32A	2P+E	6.0	KG32	T202/SGZ003*KL2V	KL2V	160	85	80	-	-	150	4.0	23	19
16A	3P+E	6.0	KH16	T200/SGZ003*KS2V	KS2V	120	85	80	-	-	110	4.0	23	19
20A	3P+E	6.0	KH20	T200/SGZ003*KS2V	KS2V	120	85	80	-	-	110	4.0	23	19
25A	3P+E	10.0	KG20	T203/SGZ003*KS2V	KS2V	120	85	80	-	-	110	4.0	23	19
32A	3P+E	10.0	KG32	T203/SGZ003*KL2V	KL2V	160	85	80	-	-	150	4.0	23	19
40A	3P+E	16.0	KG41	T203/SGZ003*KL2V	KL2V	190	100	91	-	-	178	5.5	29	23
63A	3P+E	16.0	KG64	T203/SGZ003*KL2V	KL2V ¹⁵⁾	190	100	91	-	-	178	5.5	-	-
63A	3P+E	35.0	KH63	T200/SGZ003*KL2V	KL2V ¹⁶⁾	250	145	100	124	229	-	5.5	29	23
80A	3P+E	35.0	KG80	T203/SGZ003*KL2V	KL2V	250	145	100	124	229	-	5.5	37.5	23
100A	3P+E	50.0	KG100	T203/SGY003 *9P65	ABS ¹⁷⁾	280	190	130	164	254	-	5.5	-	-
125A	3P+E	70.0	KG105	T203/SGY003 *9P65	ABS ¹⁷⁾	380	280	130	254	354	-	5.5	-	-
160A	3P+E	95.0	KG161	T103/SGY003 *9P65	ABS ¹⁷⁾	380	280	180	254	354	-	5.5	-	-
200A	3P+E	185	KG211	T103/SGY003 *9P65	ABS ¹⁷⁾	380	280	180	254	354	-	5.5	-	-
250A	3P+E	185	KG251	T103/SGY003 *9P65	ABS ¹⁷⁾	380	280	180	254	354	-	5.5	-	-
315A	3P+E	185	KG316	T103/SGY003 *9P65	ABS ¹⁷⁾	560	380	180	354	534	-	5.5	-	-
400A	3P+E	240	930S	KF401K300P65 SIS1	CAB-P	600	400	220	372 ¹⁶⁾	572 ¹⁶⁾	-	10	-	-
630A	3P+E	300	930S	KF631K300P65 SIS1	CAB-P	700	500	270	480 ¹⁶⁾	780 ¹⁶⁾	-	10	-	-
800A	3P+E	400	930S	KF800K300P65 SIS1	CAB-P	800	600	300	580 ¹⁶⁾	880 ¹⁶⁾	-	10	-	-
1250A	3P+E	630	930S	KF1250K300P65 SIS1	CAB-P	1000	800	300	780 ¹⁶⁾	1080 ¹⁶⁾	-	10	-	-
16A	TPNE	6.0	KH16	T207/SGZ003*KS2V	KS2V	120	85	80	-	-	110	4.0	23	19
20A	TPNE	6.0	KH20	T207/SGZ003*KS2V	KS2V	120	85	80	-	-	110	4.0	23	19
25A	TPNE	10.0	KG20	T203/SGZ003*KS2V	KS2V	120	85	80	-	-	110	4.0	23	19
32A	TPNE	10.0	KG32	T203/SGZ003*KL2V	KL2V	160	85	80	-	-	150	4.0	23	19
40A	TPNE	16.0	KG41	T203/SGZ003*KL2V	KL2V	190	100	91	-	-	178	5.5	29	23
63A	TPNE	16.0	KG64	T203/SGZ003*KL2V	KL2V	190	100	91	-	-	178	5.5	29	23
63A	TPNE	35.0	KH63	T207/SGZ003*KL2V	KL2V	250	145	100	124	229	-	5.5	37.5	23
80A	TPNE	35.0	KG80	T203/SGZ003*KL2V	KL2V	250	145	100	124	229	-	5.5	37.5	23
100A	TPNE	50.0	KG100	T205/SGZ003 *9P65	ABS ¹⁷⁾	280	190	130	164	254	-	5.5	-	-
125A	TPNE	70.0	KG105	T205/SGZ003 *9P65	ABS ¹⁷⁾	380	280	130	254	354	-	5.5	-	-
160A	TPNE	95.0	KG161	T105/SGZ003 *9P65	ABS ¹⁷⁾	380	280	180	254	354	-	5.5	-	-
200A	TPNE	185	KG211	T105/SGZ003 *9P65	ABS ¹⁷⁾	380	280	180	254	354	-	5.5	-	-
250A	TPNE	185	KG251	T105/SGZ003 *9P65	ABS ¹⁷⁾	380	280	180	254	354	-	5.5	-	-
315A	TPNE	185	KG316	T105/SGZ003 *9P65	ABS ¹⁷⁾	560	380	180	354	534	-	5.5	-	-
400A	TPNE	240	930S	KF401K300P65 SIS2	CAB-P	600	400	220	372 ¹⁶⁾	572 ¹⁶⁾	-	10	-	-
630A	TPNE	300	930S	KF631K300P65 SIS2	CAB-P	700	500	270	480 ¹⁶⁾	780 ¹⁶⁾	-	10	-	-
800A	TPNE	400	930S	KF800K300P65 SIS2	CAB-P	800	600	300	580 ¹⁶⁾	880 ¹⁶⁾	-	10	-	-
1250A	TPNE	630	930S	KF1250K300P65 SIS2	CAB-P	1000	800	300	780 ¹⁶⁾	1080 ¹⁶⁾	-	10	-	-
16A	4P+E	6.0	KH16	T204/SGY003*KS2V	KS2V	120	85	80	-	-	110	4.0	23	19
20A	4P+E	6.0	KH20	T204/SGY003*KS2V	KS2V	120	85	80	-	-	110	4.0	23	19
25A	4P+E	10	KG20	T204/SGY003*KS2V	KS2V	120	85	80	-	-	110	4.0	23	19
32A	4P+E	10	KG32	T204/SGY003*KL2V	KL2V	160	85	80	-	-	150	4.0	23	19
40A	4P+E	16	KG41	T204/SGY003*KL2V	KL2V	190	100	91	-	-	178	5.5	29	23
63A	4P+E	16	KG64	T204/SGY003*KL2V	KL2V	190	100	91	-	-	178	5.5	29	23
63A	4P+E	35	KH63	T204/SGY003*KL2V	KL2V	250	145	100	124	229	-	5.5	37.5	23
80A	4P+E	35	KG80	T204/SGY003*KL2V	KL2V	250	145	100	124	229	-	5.5	37.5	23
100A	4P+E	50	KG100	T204/SGY003 *9P65	ABS ¹⁷⁾	280	190	130	164	254	-	5.5	-	-
125A	4P+E	70	KG105	T204/SGY003 *9P65	ABS ¹⁷⁾	380	280	130	254	354	-	5.5	-	-
160A	4P+E	95	KG161	T104/SGY003 *9P65	ABS ¹⁷⁾	380	280	180	254	354	-	5.5	-	-
200A	4P+E	185	KG211	T104/SGY003 *9P65	ABS ¹⁷⁾	380	280	180	254	354	-	5.5	-	-
250A	4P+E	185	KG251	T104/SGY003 *9P65	ABS ¹⁷⁾	380	280	180	254	354	-	5.5	-	-
315A	4P+E	185	KG316	T104/SGY003 *9P65	ABS ¹⁷⁾	560	380	180	354	534	-	5.5	-	-
400A	4P+E	240	930S	KF401K400P65 SIS1	CAB-P	600	400	220	372 ¹⁶⁾	572 ¹⁶⁾	-	10	-	-
630A	4P+E	300	930S	KF631K400P65 SIS1	CAB-P	700	500	270	480 ¹⁶⁾	780 ¹⁶⁾	-	10	-	-
800A	4P+E	400	930S	KF800K400P65 SIS1	CAB-P	800	600	300	580 ¹⁶⁾	880 ¹⁶⁾	-	10	-	-
1250A	4P+E	400	930S	KF1250K400P65 SIS1	CAB-P	1000	800	300	780 ¹⁶⁾	1080 ¹⁶⁾	-	10	-	-
25A	6P+E	6.0	KG20B	T206/SGY003 *9P65	ABS ¹⁷⁾	280	190	130	164	254	-	5.5	-	-
32A	6P+E	6.0	KG32B	T206/SGY003 *9P65	ABS ¹⁷⁾	280	190	130	164	254	-	5.5	-	-
40A	6P+E	16	KG41B	T206/SGY003 *9P65	ABS ¹⁷⁾	280	190	130	164	254	-	5.5	-	-
63A	6P+E	16	KG64B	T206/SGY003 *9P65	ABS ¹⁷⁾	280	190	130	164	254	-	5.5	-	-
80A	6P+E	35	KG80C	T206/SGY003 *9P65	ABS ¹⁷⁾	280	280	180	254	254	-	5.5	-	-
100A	6P+E	50	KG100C	T206/SGY003 *9P65	ABS ¹⁷⁾	280	280	180	254	254	-	5.5	-	-
125A	6P+E	70	KG105C	T206/SGY003 *9P65	ABS ¹⁷⁾	380	280	180	254	354	-	5.5	-	-
160A	6P+E	95	KG161	T106/SGY003 *9P65	ABS ¹⁷⁾	560	380	180	354	534	-	5.5	-	-

15) KG64 - suitable for cable size up to 16mm²

16) KH63 - suitable for cable size up to 25mm²

17) Polycarbonate PC version available on request



IP65 Thermoplastic Enclosed Switch CHANGE-OVER 1-OFF-2

Switch Rating	Number of Poles mm ²	Cable Size	Switch Reference	Enclosure Type	Enclosure Dimension (mm)			Mounting Dimension (mm)		
					A	B	H	E	F	D10
25A	3P	6.0	KG20B T903/SGY003 *9P65	ABS ¹⁵⁾	280	190	130	164	254	5.5
32A	3P	6.0	KG32B T903/SGY003 *9P65	ABS ¹⁵⁾	280	190	130	164	254	5.5
40A	3P	16	KG41B T903/SGY003 *9P65	ABS ¹⁵⁾	280	190	130	164	254	5.5
80A	3P	35	KG80C T903/SGY003 *9P65	ABS ¹⁵⁾	280	280	180	164	254	5.5
100A	3P	50	KG100C T903/SGY003 *9P65	ABS ¹⁵⁾	280	280	180	164	254	5.5
125A	3P	95	KG105C T903/SGY003 *9P65	ABS ¹⁵⁾	380	280	180	254	354	5.5
160A	3P	95	KG162 T903/SGY003 *9P65	ABS ¹⁵⁾	560	380	180	354	534	5.5
25A	4P	6.0	KG20B T904/SGY003 *9P65	ABS ¹⁵⁾	280	190	130	164	254	5.5
32A	4P	6.0	KG32B T904/SGY003 *9P65	ABS ¹⁵⁾	280	190	130	164	254	5.5
40A	4P	16	KG41B T904/SGY003 *9P65	ABS ¹⁵⁾	280	190	130	164	254	5.5
80A	4P	35	KG80C T904/SGY003 *9P65	ABS ¹⁵⁾	280	280	180	254	254	5.5
100A	4P	50	KG100C T904/SGY003 *9P65	ABS ¹⁵⁾	280	280	180	254	254	5.5
125A	4P	95	KG105C T904/SGY003 *9P65	ABS ¹⁵⁾	380	280	180	254	354	5.5
160A	4P	95	KG162 T904/SGY003 *9P65	ABS ¹⁵⁾	560	380	180	354	534	5.5
250A	4P	95	930S KF252 K950P65 SIS1	CAB-P	700	500	270	480 ¹⁶⁾	780 ¹⁶⁾	10
400A	4P	240	930S KF402 K950P65 SIS1	CAB-P	800	600	300	580 ¹⁶⁾	880 ¹⁶⁾	10
630A	4P	300	930S KF632 K950P65 SIS1	CAB-P	1000	800	300	780 ¹⁶⁾	1080 ¹⁶⁾	10

Dimensions in mm



ON-OFF enclosed switch in KLV/KSV Enclosure

ON-OFF enclosed switch in ABS/PC Enclosure

Change-over enclosed switch in ABS/PC Enclosure

ON-OFF enclosed switch in CAB-P Enclosure

Change-over enclosed switch in CAB-P Enclosure

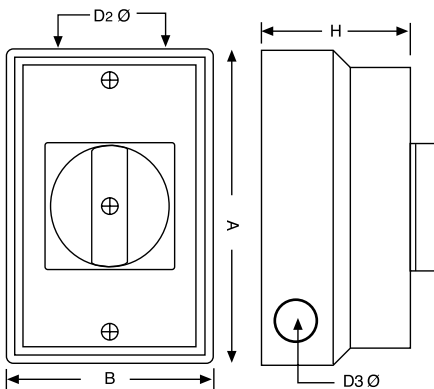

Dimension of Enclosed switch in KLV/KSV Enclosure

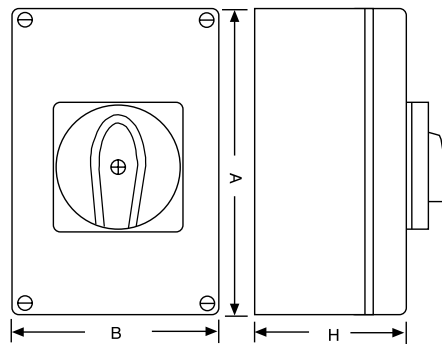

Dimension of Enclosed switch in ABS/PC/PL Enclosure

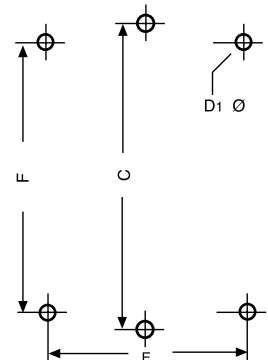

Enclosed switch Mounting Dimensions

Steel Enclosed Switch - General Purpose IP40

SECURITY

Padlockable handle prevents unauthorised operation



SAFETY

Tinned earth block for solid earth connection



FLEXIBILITY

Roomy enclosure of sheet steel allows easy wiring

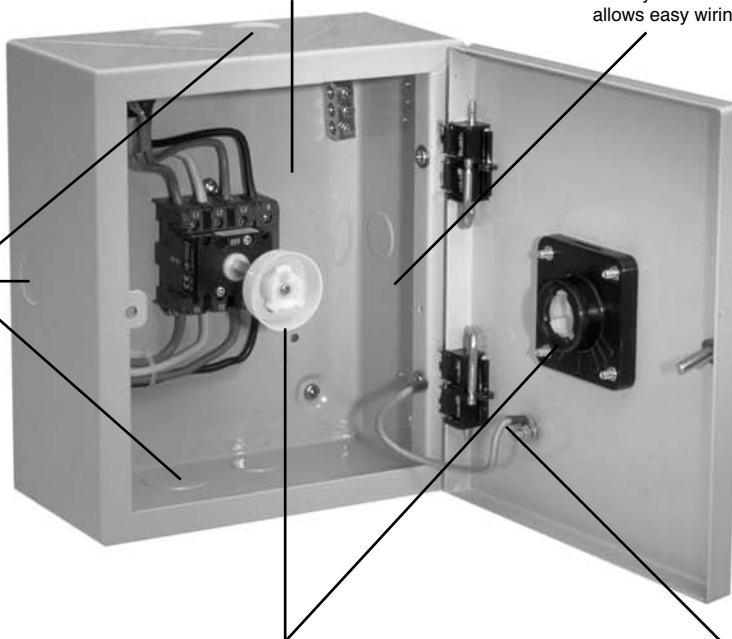

FLEXIBILITY

Entries from the top, bottom and sides using conduits or trunkings for enclosed switches up to 100A rating. For switches above 100A, gland plate openings are provided for top and bottom entries



SAFETY

Door interlock prevents door from being opened when the switch is in the "ON" position

SAFETY

Enclosure base and cover linked by cable to ensure good earth connectivity

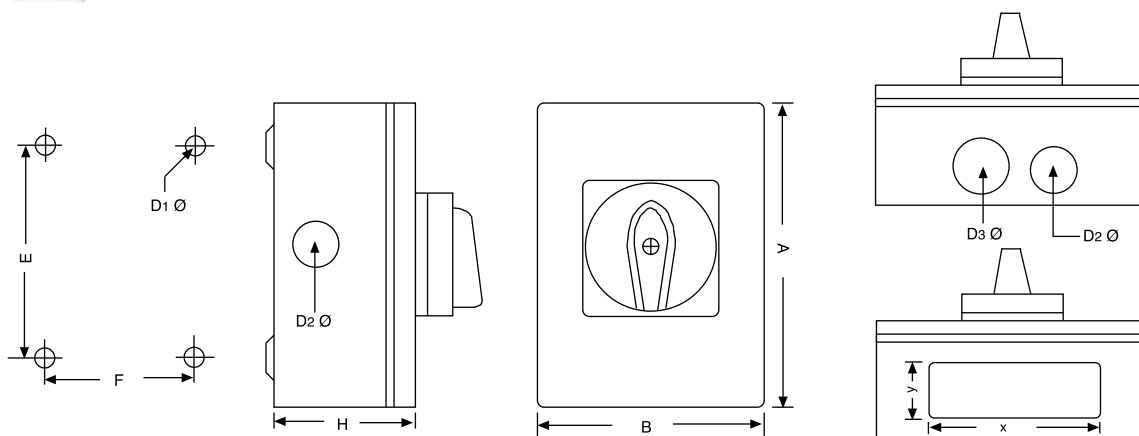



IP40 General Purpose Steel Enclosed Switch ON-OFF

Switch Rating	Number of Poles	Cable Size mm ²	Switch Reference	Enclosure Dimension (mm)			Mounting Dimension (mm)			Entries Dimension (mm)			
				A	B	H	E	F	D1ø	D2ø	D3ø	x	y
25A	2P+E	6.0	KG20B T202/SGY005*9M40	230	200	120	175	145	4	25	32	-	-
32A	2P+E	6.0	KG32B T202/SGY005*9M40	230	200	120	175	145	4	25	32	-	-
40A	2P+E	16.0	KG41B T202/SGY005*9M40	230	200	120	175	145	4	25	32	-	-
63A	2P+E	16.0	KG64B T202/SGY005*9M40	230	200	120	175	145	4	25	32	-	-
16A	3P+E	6.0	KH16B T203/SG2107*9M40	230	200	120	175	145	4	25	32	-	-
20A	3P+E	6.0	KH20B T203/SG2107*9M40	230	200	120	175	145	4	25	32	-	-
25A	3P+E	6.0	KG20B T203/SGY005*9M40	230	200	120	175	145	4	25	32	-	-
32A	3P+E	6.0	KG32B T203/SGY005*9M40	230	200	120	175	145	4	25	32	-	-
40A	3P+E	16.0	KG41B T203/SGY005*9M40	230	200	120	175	145	4	25	32	-	-
63A	3P+E	16.0	KH63 T203/SGY005*9M40	230	200	120	175	145	4	25	32	-	-
80A	3P+E	35.0	KG80 T203/SGY005*9M40	230	200	120	175	145	4	25	32	-	-
100A	3P+E	50.0	KG100 T203/SGY005*9M40	230	200	120	175	145	4	25	32	-	-
125A	3P+E	70	KG105 T203/SGZ005*9M40	300	250	200	250	200	10	-	-	200	140
160A	3P+E	95	KG161 T103/SGZ005*9M40	300	250	200	250	200	10	-	-	200	140
200A	3P+E	185	KG211 T103/SGZ005*9M40	400	300	200	350	250	10	-	-	250	140
250A	3P+E	185	KG251 T103/SGZ005*9M40	400	300	200	350	250	10	-	-	250	140
315A	3P+E	185	KG316 T103/SGZ005*9M40	400	300	200	350	250	10	-	-	250	140
400A	3P+E	240	930S KF401K300M40 SIS2	600	500	260	550	450	10	-	-	450	200
630A	3P+E	300	930S KF631K300M40 SIS2	600	500	260	550	450	10	-	-	450	200
800A	3P+E	400	930S KF800K300M40 SIS2	800	600	260	750	550	10	-	-	550	200
16A	TPNE	6.0	KH16B T207/SG2107*9M40	230	200	120	175	145	4	25	32	-	-
20A	TPNE	6.0	KH20B T207/SG2107*9M40	230	200	120	175	145	4	25	32	-	-
25A	TPNE	10.0	KG20B T207/SG2107*9M40	230	200	120	175	145	4	25	32	-	-
32A	TPNE	10.0	KG32B T207/SG2107*9M40	230	200	120	175	145	4	25	32	-	-
40A	TPNE	16.0	KG41B T207/SG2131*9M40	230	200	120	175	145	4	25	32	-	-
63A	TPNE	35.0	KH63 T207/SG2131*9M40	230	200	120	175	145	4	25	32	-	-
80A	TPNE	35.0	KG80 T203/SGC800*9M40	230	200	120	175	145	4	25	32	-	-
100A	TPNE	50.0	KG100 T207/SG2110*9M40	230	200	120	175	145	4	25	32	-	-
125A	TPNE	70	KG105 T207/SGZ005*9M40	300	250	200	250	200	10	-	-	200	140
160A	TPNE	95	KG161 T107/SGZ005*9M40	300	250	200	250	200	10	-	-	200	140
200A	TPNE	185	KG211 T107/SGZ005*9M40	400	300	200	350	250	10	-	-	250	140
250A	TPNE	185	KG251 T107/SGZ005*9M40	400	300	200	350	250	10	-	-	250	140
315A	TPNE	185	KG316 T107/SGZ005*9M40	400	300	200	350	250	10	-	-	250	140
400A	TPNE	240	930S KF401K300M40 SIS2	600	500	260	550	450	10	-	-	450	200
630A	TPNE	300	930S KF631K300M40 SIS2	600	500	260	550	450	10	-	-	450	200
800A	TPNE	400	930S KF800K300M40 SIS2	800	600	260	750	550	10	-	-	550	200
16A	4P+E	6.0	KH16B T204/SGY005*9M40	230	200	120	175	145	4	25	32	-	-
20A	4P+E	6.0	KH20B T204/SGY005*9M40	230	200	120	175	145	4	25	32	-	-
25A	4P+E	10.0	KG20B T204/SGY005*9M40	230	200	120	175	145	4	25	32	-	-
32A	4P+E	10.0	KG32B T204/SGY005*9M40	230	200	120	175	145	4	25	32	-	-
40A	4P+E	16.0	KG41B T204/SGY005*9M40	230	200	120	175	145	4	25	32	-	-
63A	4P+E	35.0	KH63 T204/SGY005*9M40	230	200	120	175	145	4	25	32	-	-
80A	4P+E	35.0	KG80 T204/SGY005*9M40	230	200	120	175	145	4	25	32	-	-
100A	4P+E	50.0	KG100 T204/SGY005*9M40	230	200	120	175	145	4	25	32	-	-
125A	4P+E	70	KG105 T204/SGY005*9M40	300	250	200	250	200	10	-	-	200	140
160A	4P+E	95	KG161 T104/SGY005*9M40	300	250	200	250	200	10	-	-	200	140
200A	4P+E	185	KG211 T104/SGY005*9M40	400	300	200	350	250	10	-	-	250	140
250A	4P+E	185	KG251 T104/SGY005*9M40	400	300	200	350	250	10	-	-	250	140
315A	4P+E	185	KG316 T104/SGY005*9M40	400	300	200	350	250	10	-	-	250	140
400A	4P+E	240	930S KF401K400M40 SIS1	600	500	260	550	450	10	-	-	450	200
630A	4P+E	300	930S KF631K400M40 SIS1	600	500	260	550	450	10	-	-	450	200
800A	4P+E	400	930S KF800K400M40 SIS1	800	600	260	750	550	10	-	-	550	200

Steel Enclosed Switch - IP55 Weather Proof

SECURITY

Lockable door to prevent unauthorised entry

SECURITY

Padlockable handle prevents unauthorised operation

WEATHER PROOF

The body is overfolded at the front to serve as a gutter

WEATHER PROOF

Polyurethane one-piece gasket provides a continuous seal so maximizing the IP rating

SAFETY

Door interlock prevents door from being open when the switch is in the "ON" position

HIGH IMPACT STRENGTH

Steel plate of 1.2 to 1.5 mm with vertical profiles fitted to the door to enhance rigidity for enclosures higher than 500mm

SAFETY

Earthing points on body, door and mounting plate ensure good earth continuity

Dimensions in mm

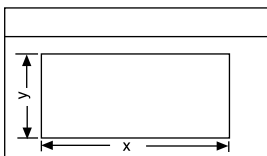

Gland plate opening

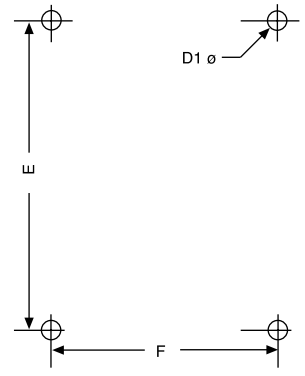
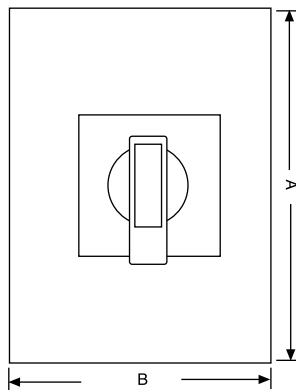
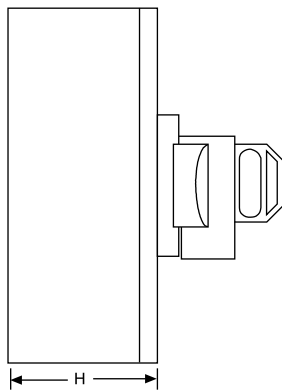

Mounting Dimensions



IP55 Weather Proof Steel Enclosed Switch ON-OFF

Switch Rating	Number of Poles	Cable Size	Switch Reference	Enclosure Dimension (mm)			Mounting Dimension (mm)			Gland Plate Opening(mm)		Remarks ¹⁹⁾
				A	B	H	E	F	D1ø	x	y	
40A	3P+E	6.0	KG41B T203/SGY009 *9M55	250	200	150	200	150	6	-	-	CRN2520/150
63A	3P+E	35	KH63 T203/SGY009 *9M55	300	250	150	250	200	6	175	61	CRN3025/150
80A	3P+E	35	KG80 T203/SGY009 *9M55	300	250	150	250	200	6	175	61	CRN3025/150
100A	3P+E	50	KG100 T203/SGY009 *9M55	300	250	150	250	200	6	175	61	CRN3025/150
125A	3P+E	70	KG105 T203/SGY009 *9M55	300	250	150	250	200	6	175	61	CRN3025/150
160A	3P+E	95	KG161 T103/SGY009 *9M55	300	250	200	250	200	6	175	61	CRN3025/200
200A	3P+E	185	KG211 T103/SGY009 *9M55	400	300	200	350	250	6	175	61	CRN43/200
250A	3P+E	185	KG251 T103/SGY009 *9M55	400	300	200	350	250	6	175	61	CRN43/200
315A	3P+E	185	KG316 T103/SGY009 *9M55	400	300	200	350	250	6	175	61	CRN43/200
400A	3P+E	240	930S KF401K300M55 SIS1	600	500	260	550	450	10	420	120	CRN65/250
630A	3P+E	300	930S KF631K300M55 SIS1	600	500	260	550	450	10	420	120	CRN65/250
800A	3P+E	400	930S KF800K300M55 SIS1	800	600	260	750	550	10	420	120	CRN65/250
1250A	3P+E	630	930S KF1250K300M55 SIS1	1000	800	260	950	750	10	420	120	CRN108/250
40A	TPNE	6.0	KG41B T207/SGY009 *9M55	250	200	150	200	150	6	-	-	CRN2520/150
63A	TPNE	35	KH63 T207/SGY009 *9M55	300	250	150	250	200	6	175	61	CRN3025/150
80A	TPNE	35	KG80 T207/SGY009 *9M55	300	250	150	250	200	6	175	61	CRN3025/150
100A	TPNE	50	KG100 T207/SGY009 *9M55	300	250	150	250	200	6	175	61	CRN3025/150
125A	TPNE	70	KG105 T207/SGY009 *9M55	300	250	150	250	200	6	175	61	CRN3025/150
160A	TPNE	95	KG161 T107/SGY009 *9M55	300	250	200	250	200	6	175	61	CRN3025/200
200A	TPNE	185	KG211 T107/SGY009 *9M55	400	300	200	350	250	6	175	61	CRN43/200
250A	TPNE	185	KG251 T107/SGY009 *9M55	400	300	200	350	250	6	175	61	CRN43/200
315A	TPNE	185	KG316 T107/SGY009 *9M55	400	300	200	350	250	6	175	61	CRN43/200
400A	TPNE	240	930S KF401K300M55 SIS2	600	500	260	550	450	10	420	120	CRN65/250
630A	TPNE	300	930S KF631K300M55 SIS2	600	500	260	550	450	10	420	120	CRN65/250
800A	TPNE	400	930S KF800K300M55 SIS2	800	600	260	750	550	10	420	120	CRN86/250
1250A	TPNE	630	930S KF1250K300M55 SIS2	1000	800	260	950	750	10	420	120	CRN108/250
40A	4P+E	6.0	KG41B T204/SGY009 *9M55	250	200	150	200	150	6	-	-	CRN2520/150
63A	4P+E	35	KH63 T204/SGY009 *9M55	300	250	150	250	200	6	175	61	CRN3025/150
80A	4P+E	35	KG80 T204/SGY009 *9M55	300	250	150	250	200	6	175	61	CRN3025/150
100A	4P+E	50	KG100 T204/SGY009 *9M55	300	250	150	250	200	6	175	61	CRN3025/150
125A	4P+E	70	KG105 T204/SGY009 *9M55	300	250	150	250	200	6	175	61	CRN3025/150
160A	4P+E	95	KG161 T104/SGY009 *9M55	300	250	200	250	200	6	175	61	CRN3025/200
200A	4P+E	185	KG211 T104/SGY009 *9M55	400	300	200	350	250	6	175	61	CRN43/200
250A	4P+E	185	KG251 T104/SGY009 *9M55	400	300	200	350	250	6	175	61	CRN43/200
315A	4P+E	185	KG316 T104/SGY009 *9M55	400	300	200	350	250	6	175	61	CRN43/200
400A	4P+E	240	930S KF401K400M55 SIS1	600	500	260	550	450	10	420	120	CRN65/250
630A	4P+E	300	930S KF631K400M55 SIS1	600	500	260	550	450	10	420	120	CRN65/250
800A	4P+E	400	930S KF800K400M55 SIS1	800	600	260	750	550	10	420	120	CRN86/250
1250A	4P+E	630	930S KF1250K400M55 SIS1	1000	800	260	950	750	10	420	120	CRN108/250
40A	6P+E	6	KG41B T206/SGY009 *9M55	250	200	150	200	150	6	-	-	CRN2520/150
80A	6P+E	35	KG80C T206/SGY009 *9M55	400	300	200	350	250	6	175	61	CRN43/200
100A	6P+E	50	KG100 T206/SGY009 *9M55	400	300	200	350	250	6	175	61	CRN43/200
125A	6P+E	70	KG105C T206/SGY009 *9M55	400	300	200	350	250	6	175	61	CRN43/200
160A	6P+E	95	KG161 T106/SGY009 *9M55	500	400	200	450	350	6	261	120	CRN54/200



IP55 Weather Proof Steel Enclosed Switch CHANGE-OVER 1-OFF-2

Switch Rating	Number of Poles	Cable Size	Switch Reference	Enclosure Dimension (mm)			Mounting Dimension (mm)			Gland Plate Opening(mm)		Remarks ¹⁹⁾
				A	B	H	E	F	D1ø	x	y	
40A	3P	6	KG41B T903/SGY009 *9M55	300	250	150	200	150	6	175	61	CRN3025/150
80A	3P	35	KG80C T903/SGY009 *9M55	400	300	200	350	250	6	175	61	CRN43/200
100A	3P	50	KG100C T903/SGY009 *9M55	400	300	200	350	250	6	175	61	CRN43/200
125A	3P	70	KG105C T903/SGY009 *9M55	400	300	200	350	250	6	175	61	CRN43/200
160A	3P	95	KG162 T903/SGY009 *9M55	500	400	200	450	350	6	261	120	CRN54/200
40A	4P	6	KG41B T904/SGY009 *9M55	300	250	150	250	200	6	175	61	CRN3025/150
80A	4P	35	KG80C T904/SGY009 *9M55	400	300	200	350	250	6	175	61	CRN43/200
100A	4P	50	KG100C T904/SGY009 *9M55	400	300	200	350	250	6	175	61	CRN43/200
125A	4P	70	KG105C T904/SGY009 *9M55	400	300	200	350	250	6	175	61	CRN43/200
160A	4P	95	KG162 T904/SGY009 *9M55	500	400	200	450	350	6	261	120	CRN54/200
250A	4P	95	930S KF252K950M55 SIS1	600	600	300	550	550	10	-	-	LA035520
400A	4P	240	930S KF402K950M55 SIS1	800	600	400	750	550	10	-	-	LA035528
630A	4P	300	930S KF632K950M55 SIS1	800	600	400	750	550	10	-	-	LA035528
800A	4P	400	930S KF802K950M55 SIS1	1000	800	400	950	750	10	-	-	LA035529
1000A	4P	630	930S KF1252K950M55 SIS1	1000	800	400	950	750	10	-	-	LA035529

¹⁹⁾ Enclosure Type subject to changes without notice

Stainless Steel Enclosed Switch - IP65 Weather Proof



Dimensions in mm

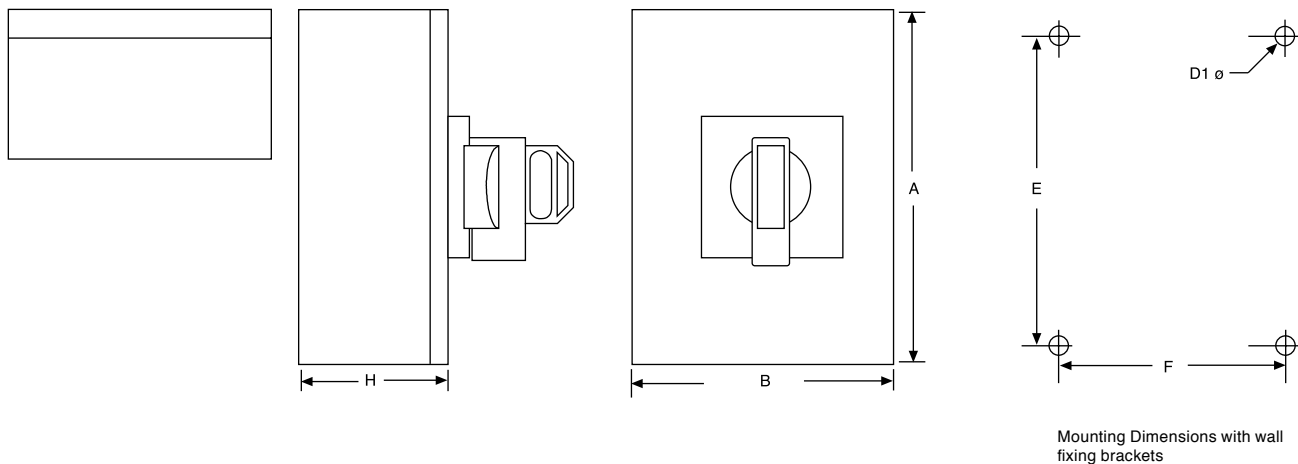



IP65 Weather Proof Steel Enclosed Switch ON-OFF

Switch Rating	Number of Poles	Cable Size	Switch Reference	Enclosure Dimension (mm)			Mounting ²¹⁾ Dimension (mm)			Remarks ²⁰⁾
				A	B	H	E	F	D ₁₀	
40A	3P+E	16	KG41B T203/SGY010 *9S65	300	250	150	360	200	9	CRSX3025/150
63A	3P+E	35	KH63 T203/SGY010 *9S65	300	250	150	360	200	9	CRSX3025/150
80A	3P+E	35	KG80 T203/SGY010 *9S65	300	250	150	360	200	9	CRSX3025/150
100A	3P+E	50	KG100 T203/SGY010 *9S65	300	250	150	360	200	9	CRSX3025/150
125A	3P+E	70	KG105 T203/SGY010 *9S65	300	250	150	360	200	9	CRSX3025/150
160A	3P+E	95	KG161 T103/SGY010 *9S65	400	300	200	460	250	9	CRSX43/200
200A	3P+E	185	KG211 T103/SGY010 *9S65	400	300	200	460	250	9	CRSX43/200
250A	3P+E	185	KG251 T103/SGY010 *9S65	400	300	200	460	250	9	CRSX43/200
315A	3P+E	185	KG316 T103/SGY010 *9S65	500	400	200	560	350	9	CRSX54/200
400A	3P+E	240	930S KF401K300S65 SIS1	700	500	250	760	450	10	CRSX76/250
630A	3P+E	300	930S KF631K300S65 SIS1	700	500	250	760	450	10	CRSX76/250
800A	3P+E	400	930S KF800K300S65 SIS1	800	600	250	730	530	10	CRSX86/250
40A	TPNE	16	KG41B T207/SGY010 *9S65	300	250	150	360	200	9	CRSX3025/150
63A	TPNE	35	KH63 T207/SGY010 *9S65	300	250	150	360	200	9	CRSX3025/150
80A	TPNE	35	KG80 T207/SGY010 *9S65	300	250	150	360	200	9	CRSX3025/150
100A	TPNE	50	KG100 T207/SGY010 *9S65	300	250	150	360	200	9	CRSX3025/150
125A	TPNE	70	KG105 T207/SGY010 *9S65	300	250	150	360	200	9	CRSX3025/150
160A	TPNE	95	KG161 T107/SGY010 *9S65	400	300	200	460	250	9	CRSX43/200
200A	TPNE	185	KG211 T107/SGY010 *9S65	400	300	200	460	250	9	CRSX43/200
250A	TPNE	185	KG251 T107/SGY010 *9S65	400	300	200	460	250	9	CRSX43/200
315A	TPNE	185	KG316 T107/SGY010 *9S65	500	400	200	560	350	9	CRSX54/200
400A	TPNE	240	930S KF401K300S65 SIS2	700	500	250	760	450	10	CRSX76/250
630A	TPNE	300	930S KF631K300S65 SIS2	700	500	250	760	450	10	CRSX76/250
800A	TPNE	400	930S KF800K300S65 SIS2	800	600	250	730	530	10	CRSX86/250
40A	4P+E	16	KG41B T204/SGY010 *9S65	300	250	150	360	200	9	CRSX3025/150
63A	4P+E	35	KH63 T204/SGY010 *9S65	300	250	150	360	200	9	CRSX3025/150
80A	4P+E	35	KG80 T204/SGY010 *9S65	300	250	150	360	200	9	CRSX3025/150
100A	4P+E	50	KG100 T204/SGY010 *9S65	300	250	150	360	200	9	CRSX3025/150
125A	4P+E	70	KG105 T204/SGY010 *9S65	300	250	150	360	200	9	CRSX3025/150
160A	4P+E	95	KG161 T104/SGY010 *9S65	400	300	200	460	250	9	CRSX43/200
200A	4P+E	185	KG211 T104/SGY010 *9S65	400	300	200	460	250	9	CRSX43/200
250A	4P+E	185	KG251 T104/SGY010 *9S65	400	300	200	460	250	9	CRSX43/200
315A	4P+E	185	KG316 T104/SGY010 *9S65	500	400	200	560	350	9	CRSX54/200
400A	4P+E	240	930S KF401K400S65 SIS1	700	500	250	760	450	10	CRSX76/250
630A	4P+E	300	930S KF631K400S65 SIS1	700	500	250	760	450	10	CRSX76/250
800A	4P+E	400	930S KF800K400S65 SIS1	800	600	250	730	530	10	CRSX86/250
40A	6P+E	16	KG41B T206/SGY010 *9S65	300	250	150	360	200	9	CRSX3025/150
80A	6P+E	35	KG80C T206/SGY010 *9S65	400	300	150	460	250	9	CRSX43/150
100A	6P+E	50	KG100C T206/SGY010 *9S65	400	300	150	460	250	9	CRSX43/150
125A	6P+E	70	KG105C T206/SGY010 *9S65	400	300	200	460	250	9	CRSX43/200
160A	6P+E	95	KG161 T106/SGY010 *9S65	500	400	200	560	350	9	CRSX54/200



IP65 Weather Proof Stainless Steel Enclosed Switch CHANGE-OVER

Switch Rating	Number of Poles	Cable Size	Switch Reference	Enclosure Dimension (mm)			Mounting ²¹⁾ Dimension (mm)			Remarks ²⁰⁾
				A	B	H	E	F	D ₁₀	
40A	3P	16	KG41B T903/SGY010 *9S65	300	250	150	360	200	9	CRSX3025/150
80A	3P	35	KG80C T903/SGY010 *9S65	400	300	150	460	250	9	CRSX43/150
100A	3P	50	KG100C T903/SGY010 *9S65	400	300	150	460	250	9	CRSX43/150
125A	3P	70	KG105C T903/SGY010 *9S65	400	300	200	460	250	9	CRSX43/200
160A	3P	95	KG16 T903/SGY010 *9S65	500	400	200	560	350	9	CRSX54/200
40A	4P	16	KG41B T904/SGY010 *9S65	300	250	150	360	200	9	CRSX3025/150
80A	4P	35	KG80C T904/SGY010 *9S65	400	300	150	460	250	9	CRSX43/150
100A	4P	50	KG100C T904/SGY010 *9S65	400	300	150	460	250	9	CRSX43/150
125A	4P	70	KG105C T904/SGY010 *9S65	400	300	200	460	250	9	CRSX43/200
160A	4P	95	KG162 T904/SGY010 *9S65	500	400	200	560	350	9	CRSX54/200

20) Enclosures type subject to change without notice
21) External mounting with wall fixing brackets